

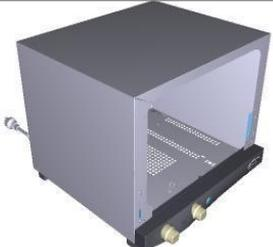

Assembly code	Assembly description	Assembly image
ASM0315A/0.D01		 A 3D rendering of a rectangular assembly with a light blue translucent front panel and a silver frame.
ASM1520A/0.D03		 A 3D rendering of a grey rectangular unit with a front panel and a yellow connector on the side.
ASM1521A/0.D01		 A 3D rendering of a grey rectangular unit with a front panel, a power cord on the left, and two yellow connectors on the bottom right.

ASM0315A/0.D01 - - FRONT

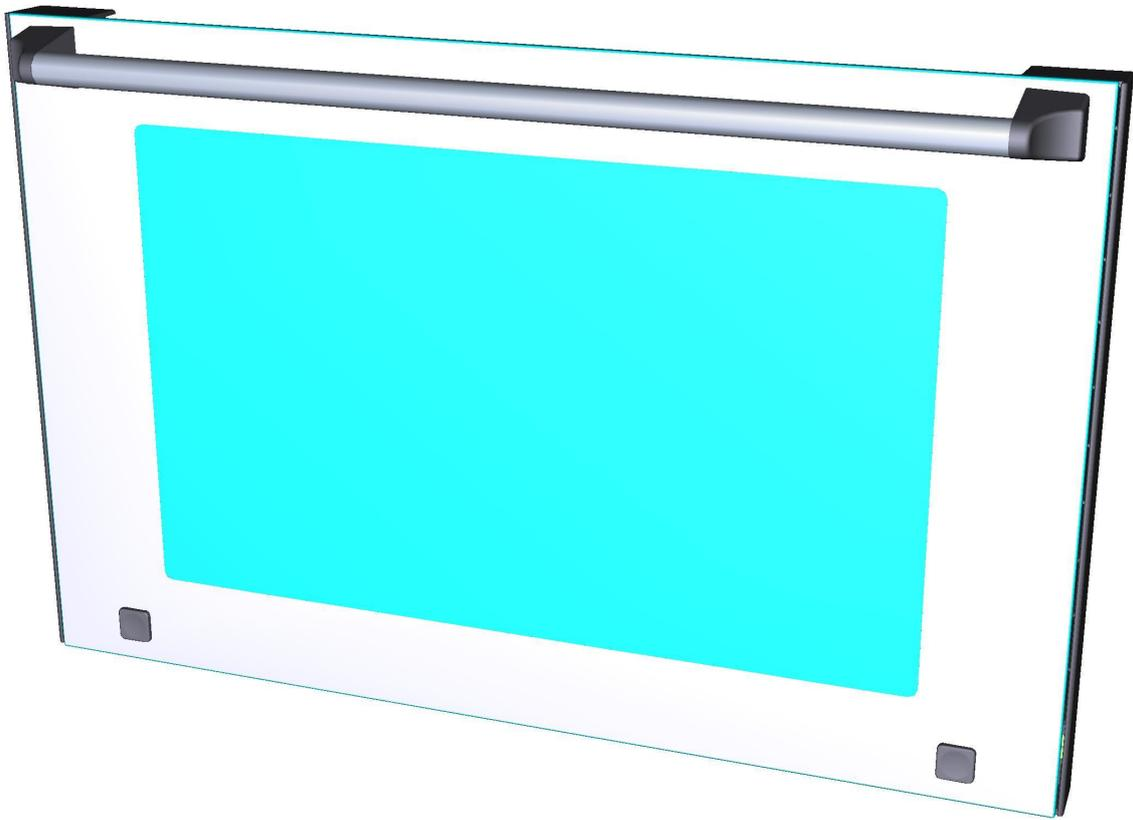

ASM0315A/0.D01 - - REAR

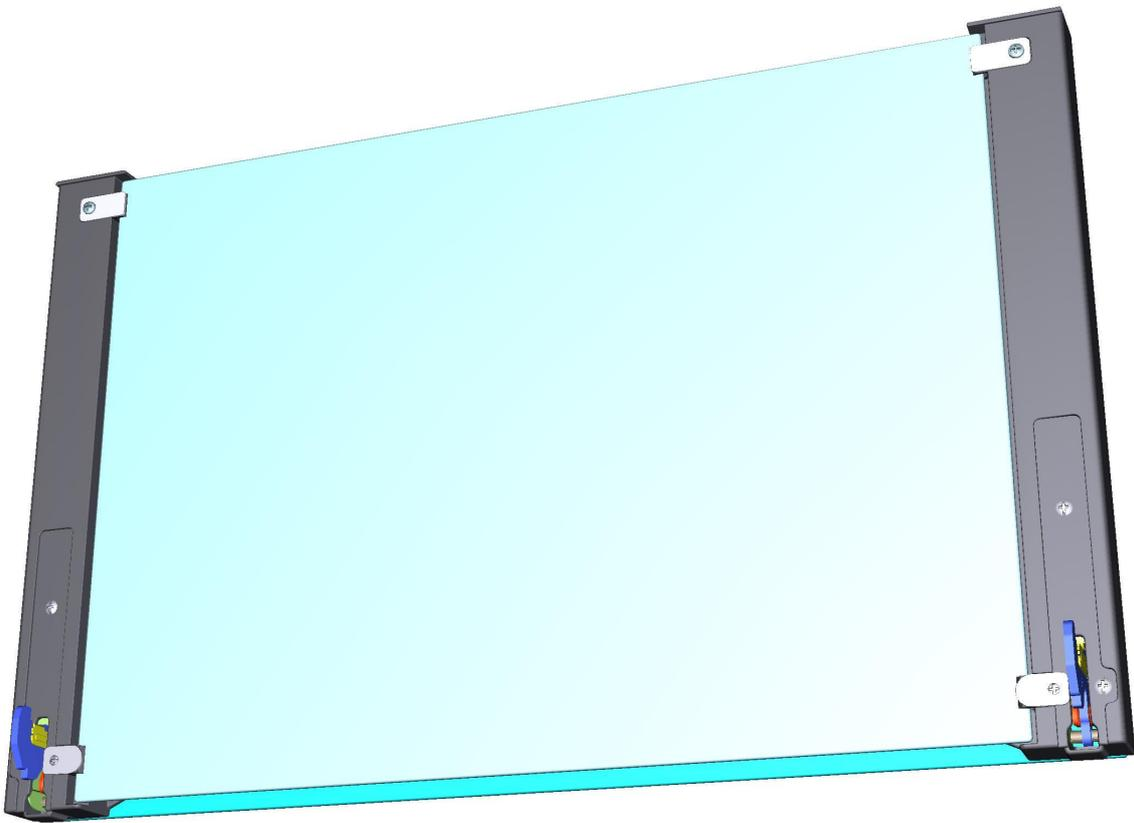



COMPONENT			SPARE PART																						
Code	Description	Image	Code	Description	Kit components																				
0H3110A	GLASS HOLDING ST. STEEL UPPER PLATE		KVP0200A	LineMicro GLASS HOLDING PLATES 4PCS KIT	<table border="1"> <thead> <tr> <th>Code</th> <th>Description</th> <th>Qty</th> <th>UOM</th> </tr> </thead> <tbody> <tr> <td>VP1752A0</td> <td>UPPER GLASS HOLDING PLATE</td> <td>2.000</td> <td>PC</td> </tr> <tr> <td>VP1753A0</td> <td>LOWER GLASS HOLDING PLATE</td> <td>2.000</td> <td>PC</td> </tr> </tbody> </table>	Code	Description	Qty	UOM	VP1752A0	UPPER GLASS HOLDING PLATE	2.000	PC	VP1753A0	LOWER GLASS HOLDING PLATE	2.000	PC								
Code	Description	Qty	UOM																						
VP1752A0	UPPER GLASS HOLDING PLATE	2.000	PC																						
VP1753A0	LOWER GLASS HOLDING PLATE	2.000	PC																						
0H3111A	GLASS HOLDING ST. STEEL LOWER PLATE		OUTOFPRODUCTIO	ITEM OUT OF PRODUCTION																					
CR1065A	LineMicro ANNA DOOR HINGE		KCR1065A	LineMicro XF023 DOOR HINGES KIT	<table border="1"> <thead> <tr> <th>Code</th> <th>Description</th> <th>Qty</th> <th>UOM</th> </tr> </thead> <tbody> <tr> <td>CR1065A1</td> <td></td> <td>2.000</td> <td>PC</td> </tr> <tr> <td>V11280A3</td> <td>M5x10 TC1/2T SCREW</td> <td>6.000</td> <td>PC</td> </tr> </tbody> </table>	Code	Description	Qty	UOM	CR1065A1		2.000	PC	V11280A3	M5x10 TC1/2T SCREW	6.000	PC								
Code	Description	Qty	UOM																						
CR1065A1		2.000	PC																						
V11280A3	M5x10 TC1/2T SCREW	6.000	PC																						
0H3195B	HANDLE TUBE L= 508 Ø18x1		K0H3195B	460x330 Line MICRO HANDLE KIT	<table border="1"> <thead> <tr> <th>Code</th> <th>Description</th> <th>Qty</th> <th>UOM</th> </tr> </thead> <tbody> <tr> <td>0H3195B0</td> <td>HANDLE TUBE L= 508 Ø18x1</td> <td>1.000</td> <td>PC</td> </tr> <tr> <td>MG1015B0</td> <td>L.MISS/L.MICR O/CHEFTOP HANDLE END</td> <td>2.000</td> <td>PC</td> </tr> <tr> <td>V11870A0</td> <td>50x50 SELF-THREADING SCREW FOR PLASTIC</td> <td>2.000</td> <td>PC</td> </tr> <tr> <td>VM1025A0</td> <td>Ø16 GREY NYLON LID</td> <td>2.000</td> <td>PC</td> </tr> </tbody> </table>	Code	Description	Qty	UOM	0H3195B0	HANDLE TUBE L= 508 Ø18x1	1.000	PC	MG1015B0	L.MISS/L.MICR O/CHEFTOP HANDLE END	2.000	PC	V11870A0	50x50 SELF-THREADING SCREW FOR PLASTIC	2.000	PC	VM1025A0	Ø16 GREY NYLON LID	2.000	PC
Code	Description	Qty	UOM																						
0H3195B0	HANDLE TUBE L= 508 Ø18x1	1.000	PC																						
MG1015B0	L.MISS/L.MICR O/CHEFTOP HANDLE END	2.000	PC																						
V11870A0	50x50 SELF-THREADING SCREW FOR PLASTIC	2.000	PC																						
VM1025A0	Ø16 GREY NYLON LID	2.000	PC																						
MG1015B	L.MISS/L.MICRO/CH EFTOP HANDLE END		KMG1015B	2 PCS. HANDLE END KIT	<table border="1"> <thead> <tr> <th>Code</th> <th>Description</th> <th>Qty</th> <th>UOM</th> </tr> </thead> <tbody> <tr> <td>MG1015B0</td> <td>L.MISS/L.MICR O/CHEFTOP HANDLE END</td> <td>2.000</td> <td>PC</td> </tr> <tr> <td>V11855A0</td> <td>5X25 SELF-TAPPING SCREW</td> <td>2.000</td> <td>PC</td> </tr> <tr> <td>V11870A0</td> <td>50x50 SELF-THREADING SCREW FOR PLASTIC</td> <td>2.000</td> <td>PC</td> </tr> <tr> <td>VM1025A0</td> <td>Ø16 GREY NYLON LID</td> <td>2.000</td> <td>PC</td> </tr> </tbody> </table>	Code	Description	Qty	UOM	MG1015B0	L.MISS/L.MICR O/CHEFTOP HANDLE END	2.000	PC	V11855A0	5X25 SELF-TAPPING SCREW	2.000	PC	V11870A0	50x50 SELF-THREADING SCREW FOR PLASTIC	2.000	PC	VM1025A0	Ø16 GREY NYLON LID	2.000	PC
Code	Description	Qty	UOM																						
MG1015B0	L.MISS/L.MICR O/CHEFTOP HANDLE END	2.000	PC																						
V11855A0	5X25 SELF-TAPPING SCREW	2.000	PC																						
V11870A0	50x50 SELF-THREADING SCREW FOR PLASTIC	2.000	PC																						
VM1025A0	Ø16 GREY NYLON LID	2.000	PC																						



COMPONENT			SPARE PART															
Code	Description	Image	Code	Description	Kit components													
GN1240A	COLUMN-GLASS BLACK SILICON SEA		KVT1190B	LINEMICRO XF043 INTERNAL GLASS KI	<table border="1"> <thead> <tr> <th>Code</th> <th>Description</th> <th>Qty</th> <th>UOM</th> </tr> </thead> <tbody> <tr> <td>GN1240A0</td> <td>COLUMN-GLA SS BLACK SILICON SEAL</td> <td>4.000</td> <td>PC</td> </tr> <tr> <td>VT1190B0</td> <td>LineMicro XF043 712x372x4 INTERNAL GLASS</td> <td>1.000</td> <td>PC</td> </tr> </tbody> </table>	Code	Description	Qty	UOM	GN1240A0	COLUMN-GLA SS BLACK SILICON SEAL	4.000	PC	VT1190B0	LineMicro XF043 712x372x4 INTERNAL GLASS	1.000	PC	
			Code	Description	Qty	UOM												
			GN1240A0	COLUMN-GLA SS BLACK SILICON SEAL	4.000	PC												
			VT1190B0	LineMicro XF043 712x372x4 INTERNAL GLASS	1.000	PC												
			KVT1190A	DOMENICA INT. GLASS KIT VT1190A	<table border="1"> <thead> <tr> <th>Code</th> <th>Description</th> <th>Qty</th> <th>UOM</th> </tr> </thead> <tbody> <tr> <td>GN1240A0</td> <td>COLUMN-GLA SS BLACK SILICON SEAL</td> <td>4.000</td> <td>PC</td> </tr> <tr> <td>VT1190A0</td> <td></td> <td>1.000</td> <td>PC</td> </tr> </tbody> </table>	Code	Description	Qty	UOM	GN1240A0	COLUMN-GLA SS BLACK SILICON SEAL	4.000	PC	VT1190A0		1.000	PC	
			Code	Description	Qty	UOM												
			GN1240A0	COLUMN-GLA SS BLACK SILICON SEAL	4.000	PC												
			VT1190A0		1.000	PC												
			KVT1155A	LINEMICRO XF023 INTERNAL GLASS KI	<table border="1"> <thead> <tr> <th>Code</th> <th>Description</th> <th>Qty</th> <th>UOM</th> </tr> </thead> <tbody> <tr> <td>GN1240A0</td> <td>COLUMN-GLA SS BLACK SILICON SEAL</td> <td>4.000</td> <td>PC</td> </tr> <tr> <td>VT1155A0</td> <td>INTERNAL GLASS 512X362X4 LineMicro XF02</td> <td>1.000</td> <td>PC</td> </tr> </tbody> </table>	Code	Description	Qty	UOM	GN1240A0	COLUMN-GLA SS BLACK SILICON SEAL	4.000	PC	VT1155A0	INTERNAL GLASS 512X362X4 LineMicro XF02	1.000	PC	
			Code	Description	Qty	UOM												
GN1240A0	COLUMN-GLA SS BLACK SILICON SEAL	4.000	PC															
VT1155A0	INTERNAL GLASS 512X362X4 LineMicro XF02	1.000	PC															
KVT1150A	LINEMICRO XF013 INTERNAL GLASS KI	<table border="1"> <thead> <tr> <th>Code</th> <th>Description</th> <th>Qty</th> <th>UOM</th> </tr> </thead> <tbody> <tr> <td>GN1240A0</td> <td>COLUMN-GLA SS BLACK SILICON SEAL</td> <td>4.000</td> <td>PC</td> </tr> <tr> <td>VT1150A0</td> <td>INTERNAL GLASS 512x292x4 LineMicro XF00</td> <td>1.000</td> <td>PC</td> </tr> </tbody> </table>	Code	Description	Qty	UOM	GN1240A0	COLUMN-GLA SS BLACK SILICON SEAL	4.000	PC	VT1150A0	INTERNAL GLASS 512x292x4 LineMicro XF00	1.000	PC				
Code	Description	Qty	UOM															
GN1240A0	COLUMN-GLA SS BLACK SILICON SEAL	4.000	PC															
VT1150A0	INTERNAL GLASS 512x292x4 LineMicro XF00	1.000	PC															
KVT1145A	LINEMICRO XF003 INTERNAL GLASS KI	<table border="1"> <thead> <tr> <th>Code</th> <th>Description</th> <th>Qty</th> <th>UOM</th> </tr> </thead> <tbody> <tr> <td>GN1240A0</td> <td>COLUMN-GLA SS BLACK SILICON SEAL</td> <td>4.000</td> <td>PC</td> </tr> <tr> <td>VT1145A0</td> <td>INNER GLASS 392x292x4 BETFL L.</td> <td>1.000</td> <td>PC</td> </tr> </tbody> </table>	Code	Description	Qty	UOM	GN1240A0	COLUMN-GLA SS BLACK SILICON SEAL	4.000	PC	VT1145A0	INNER GLASS 392x292x4 BETFL L.	1.000	PC				
Code	Description	Qty	UOM															
GN1240A0	COLUMN-GLA SS BLACK SILICON SEAL	4.000	PC															
VT1145A0	INNER GLASS 392x292x4 BETFL L.	1.000	PC															
KVM1376A	XF023-XF043 RIGHT DOOR COLUMN KIT	<table border="1"> <thead> <tr> <th>Code</th> <th>Description</th> <th>Qty</th> <th>UOM</th> </tr> </thead> <tbody> <tr> <td>GN1240A0</td> <td>COLUMN-GLA SS BLACK SILICON SEAL</td> <td>2.000</td> <td>PC</td> </tr> <tr> <td>VI1865A0</td> <td>5X10 TCB+ SELF-THREADI NG SCREW</td> <td>1.000</td> <td>PC</td> </tr> <tr> <td>VI1870A0</td> <td>50x50 SELF-THREADI NG SCREW FOR PLASTIC</td> <td>1.000</td> <td>PC</td> </tr> </tbody> </table>	Code	Description	Qty	UOM	GN1240A0	COLUMN-GLA SS BLACK SILICON SEAL	2.000	PC	VI1865A0	5X10 TCB+ SELF-THREADI NG SCREW	1.000	PC	VI1870A0	50x50 SELF-THREADI NG SCREW FOR PLASTIC	1.000	PC
Code	Description	Qty	UOM															
GN1240A0	COLUMN-GLA SS BLACK SILICON SEAL	2.000	PC															
VI1865A0	5X10 TCB+ SELF-THREADI NG SCREW	1.000	PC															
VI1870A0	50x50 SELF-THREADI NG SCREW FOR PLASTIC	1.000	PC															



COMPONENT			SPARE PART																																		
Code	Description	Image	Code	Description	Kit components																																
GN1240A	COLUMN-GLASS BLACK SILICON SEA		KVM1376A	XF023-XF043 RIGHT DOOR COLUMN KIT	<table border="1"> <thead> <tr> <th>Code</th> <th>Description</th> <th>Qty</th> <th>UOM</th> </tr> </thead> <tbody> <tr> <td>VM1376A1</td> <td>H381 LMC RIGHT DOOR COLUMN</td> <td>1.000</td> <td>PC</td> </tr> <tr> <td>VM1380B0</td> <td>L.MICRO GLASS-DOOR FIXING CAP</td> <td>1.000</td> <td>PC</td> </tr> <tr> <td>VP1752A0</td> <td>UPPER GLASS HOLDING PLATE</td> <td>1.000</td> <td>PC</td> </tr> <tr> <td>VP1753A0</td> <td>LOWER GLASS HOLDING PLATE</td> <td>1.000</td> <td>PC</td> </tr> </tbody> </table>	Code	Description	Qty	UOM	VM1376A1	H381 LMC RIGHT DOOR COLUMN	1.000	PC	VM1380B0	L.MICRO GLASS-DOOR FIXING CAP	1.000	PC	VP1752A0	UPPER GLASS HOLDING PLATE	1.000	PC	VP1753A0	LOWER GLASS HOLDING PLATE	1.000	PC												
			Code	Description	Qty	UOM																															
			VM1376A1	H381 LMC RIGHT DOOR COLUMN	1.000	PC																															
			VM1380B0	L.MICRO GLASS-DOOR FIXING CAP	1.000	PC																															
			VP1752A0	UPPER GLASS HOLDING PLATE	1.000	PC																															
			VP1753A0	LOWER GLASS HOLDING PLATE	1.000	PC																															
			KVM1375A	XF023-XF043 LEFT DOOR COLUMN KIT	<table border="1"> <thead> <tr> <th>Code</th> <th>Description</th> <th>Qty</th> <th>UOM</th> </tr> </thead> <tbody> <tr> <td>GN1240A0</td> <td>COLUMN-GLA SS BLACK SILICON SEAL</td> <td>2.000</td> <td>PC</td> </tr> <tr> <td>VI1865A0</td> <td>5X10 TCB+ SELF-THREADI NG SCREW</td> <td>1.000</td> <td>PC</td> </tr> <tr> <td>VI1870A0</td> <td>50x50 SELF-THREADI NG SCREW FOR PLASTIC</td> <td>1.000</td> <td>PC</td> </tr> <tr> <td>VM1375A1</td> <td>H381 LMC LEFT DOOR COLUMN</td> <td>1.000</td> <td>PC</td> </tr> <tr> <td>VM1380B0</td> <td>L.MICRO GLASS-DOOR FIXING CAP</td> <td>1.000</td> <td>PC</td> </tr> <tr> <td>VP1752A0</td> <td>UPPER GLASS HOLDING PLATE</td> <td>1.000</td> <td>PC</td> </tr> <tr> <td>VP1753A0</td> <td>LOWER GLASS HOLDING PLATE</td> <td>1.000</td> <td>PC</td> </tr> </tbody> </table>	Code	Description	Qty	UOM	GN1240A0	COLUMN-GLA SS BLACK SILICON SEAL	2.000	PC	VI1865A0	5X10 TCB+ SELF-THREADI NG SCREW	1.000	PC	VI1870A0	50x50 SELF-THREADI NG SCREW FOR PLASTIC	1.000	PC	VM1375A1	H381 LMC LEFT DOOR COLUMN	1.000	PC	VM1380B0	L.MICRO GLASS-DOOR FIXING CAP	1.000	PC	VP1752A0	UPPER GLASS HOLDING PLATE	1.000	PC	VP1753A0	LOWER GLASS HOLDING PLATE	1.000	PC
			Code	Description	Qty	UOM																															
			GN1240A0	COLUMN-GLA SS BLACK SILICON SEAL	2.000	PC																															
			VI1865A0	5X10 TCB+ SELF-THREADI NG SCREW	1.000	PC																															
			VI1870A0	50x50 SELF-THREADI NG SCREW FOR PLASTIC	1.000	PC																															
			VM1375A1	H381 LMC LEFT DOOR COLUMN	1.000	PC																															
VM1380B0	L.MICRO GLASS-DOOR FIXING CAP	1.000	PC																																		
VP1752A0	UPPER GLASS HOLDING PLATE	1.000	PC																																		
VP1753A0	LOWER GLASS HOLDING PLATE	1.000	PC																																		
KVM1371A	XF003-XF013 RIGHT DOOR COLUMN KIT	<table border="1"> <thead> <tr> <th>Code</th> <th>Description</th> <th>Qty</th> <th>UOM</th> </tr> </thead> <tbody> <tr> <td>GN1240A0</td> <td>COLUMN-GLA SS BLACK SILICON SEAL</td> <td>2.000</td> <td>PC</td> </tr> <tr> <td>VI1865A0</td> <td>5X10 TCB+ SELF-THREADI NG SCREW</td> <td>1.000</td> <td>PC</td> </tr> <tr> <td>VI1870A0</td> <td>50x50 SELF-THREADI NG SCREW FOR PLASTIC</td> <td>1.000</td> <td>PC</td> </tr> <tr> <td>VM1371A1</td> <td>H311 LMC RIGHT DOOR COLUMN</td> <td>1.000</td> <td>PC</td> </tr> </tbody> </table>	Code	Description	Qty	UOM	GN1240A0	COLUMN-GLA SS BLACK SILICON SEAL	2.000	PC	VI1865A0	5X10 TCB+ SELF-THREADI NG SCREW	1.000	PC	VI1870A0	50x50 SELF-THREADI NG SCREW FOR PLASTIC	1.000	PC	VM1371A1	H311 LMC RIGHT DOOR COLUMN	1.000	PC															
Code	Description	Qty	UOM																																		
GN1240A0	COLUMN-GLA SS BLACK SILICON SEAL	2.000	PC																																		
VI1865A0	5X10 TCB+ SELF-THREADI NG SCREW	1.000	PC																																		
VI1870A0	50x50 SELF-THREADI NG SCREW FOR PLASTIC	1.000	PC																																		
VM1371A1	H311 LMC RIGHT DOOR COLUMN	1.000	PC																																		



COMPONENT			SPARE PART																															
Code	Description	Image	Code	Description	Kit components																													
GN1240A	COLUMN-GLASS BLACK SILICON SEA		KVM1371A	XF003-XF013 RIGHT DOOR COLUMN KIT	<table border="1"> <thead> <tr> <th>Code</th> <th>Description</th> <th>Qty</th> <th>UOM</th> </tr> </thead> <tbody> <tr> <td>VM1380B0</td> <td>L.MICRO GLASS-DOOR FIXING CAP</td> <td>1.000</td> <td>PC</td> </tr> <tr> <td>VP1752A0</td> <td>UPPER GLASS HOLDING PLATE</td> <td>1.000</td> <td>PC</td> </tr> <tr> <td>VP1753A0</td> <td>LOWER GLASS HOLDING PLATE</td> <td>1.000</td> <td>PC</td> </tr> </tbody> </table>	Code	Description	Qty	UOM	VM1380B0	L.MICRO GLASS-DOOR FIXING CAP	1.000	PC	VP1752A0	UPPER GLASS HOLDING PLATE	1.000	PC	VP1753A0	LOWER GLASS HOLDING PLATE	1.000	PC													
			Code	Description	Qty	UOM																												
			VM1380B0	L.MICRO GLASS-DOOR FIXING CAP	1.000	PC																												
VP1752A0	UPPER GLASS HOLDING PLATE	1.000	PC																															
VP1753A0	LOWER GLASS HOLDING PLATE	1.000	PC																															
KVM1370A	XF003-XF013 LEFT DOOR COLUMN KIT	<table border="1"> <thead> <tr> <th>Code</th> <th>Description</th> <th>Qty</th> <th>UOM</th> </tr> </thead> <tbody> <tr> <td>GN1240A0</td> <td>COLUMN-GLA SS BLACK SILICON SEAL</td> <td>2.000</td> <td>PC</td> </tr> <tr> <td>VI1865A0</td> <td>5X10 TCB+ SELF-THREADI NG SCREW</td> <td>1.000</td> <td>PC</td> </tr> <tr> <td>VI1870A0</td> <td>50x50 SELF-THREADI NG SCREW FOR PLASTIC</td> <td>1.000</td> <td>PC</td> </tr> <tr> <td>VM1370A1</td> <td>H311 LMC LEFT DOOR COLUMN</td> <td>1.000</td> <td>PC</td> </tr> <tr> <td>VM1380B0</td> <td>L.MICRO GLASS-DOOR FIXING CAP</td> <td>1.000</td> <td>PC</td> </tr> <tr> <td>VP1752A0</td> <td>UPPER GLASS HOLDING PLATE</td> <td>1.000</td> <td>PC</td> </tr> <tr> <td>VP1753A0</td> <td>LOWER GLASS HOLDING PLATE</td> <td>1.000</td> <td>PC</td> </tr> </tbody> </table>	Code	Description	Qty	UOM	GN1240A0	COLUMN-GLA SS BLACK SILICON SEAL	2.000	PC	VI1865A0	5X10 TCB+ SELF-THREADI NG SCREW	1.000	PC	VI1870A0	50x50 SELF-THREADI NG SCREW FOR PLASTIC	1.000	PC	VM1370A1	H311 LMC LEFT DOOR COLUMN	1.000	PC	VM1380B0	L.MICRO GLASS-DOOR FIXING CAP	1.000	PC	VP1752A0	UPPER GLASS HOLDING PLATE	1.000	PC	VP1753A0	LOWER GLASS HOLDING PLATE	1.000	PC
Code	Description	Qty	UOM																															
GN1240A0	COLUMN-GLA SS BLACK SILICON SEAL	2.000	PC																															
VI1865A0	5X10 TCB+ SELF-THREADI NG SCREW	1.000	PC																															
VI1870A0	50x50 SELF-THREADI NG SCREW FOR PLASTIC	1.000	PC																															
VM1370A1	H311 LMC LEFT DOOR COLUMN	1.000	PC																															
VM1380B0	L.MICRO GLASS-DOOR FIXING CAP	1.000	PC																															
VP1752A0	UPPER GLASS HOLDING PLATE	1.000	PC																															
VP1753A0	LOWER GLASS HOLDING PLATE	1.000	PC																															
KG1240A	COLUMN-GLASS GASKET 4 PCS KIT	<table border="1"> <thead> <tr> <th>Code</th> <th>Description</th> <th>Qty</th> <th>UOM</th> </tr> </thead> <tbody> <tr> <td>GN1240A0</td> <td>COLUMN-GLA SS BLACK SILICON SEAL</td> <td>4.000</td> <td>PC</td> </tr> </tbody> </table>	Code	Description	Qty	UOM	GN1240A0	COLUMN-GLA SS BLACK SILICON SEAL	4.000	PC																								
Code	Description	Qty	UOM																															
GN1240A0	COLUMN-GLA SS BLACK SILICON SEAL	4.000	PC																															
VM1375A	LEFT DOOR COLUMN L. MICRO ANNA		KVM1375A	XF023-XF043 LEFT DOOR COLUMN KIT	<table border="1"> <thead> <tr> <th>Code</th> <th>Description</th> <th>Qty</th> <th>UOM</th> </tr> </thead> <tbody> <tr> <td>GN1240A0</td> <td>COLUMN-GLA SS BLACK SILICON SEAL</td> <td>2.000</td> <td>PC</td> </tr> <tr> <td>VI1865A0</td> <td>5X10 TCB+ SELF-THREADI NG SCREW</td> <td>1.000</td> <td>PC</td> </tr> <tr> <td>VI1870A0</td> <td>50x50 SELF-THREADI NG SCREW FOR PLASTIC</td> <td>1.000</td> <td>PC</td> </tr> </tbody> </table>	Code	Description	Qty	UOM	GN1240A0	COLUMN-GLA SS BLACK SILICON SEAL	2.000	PC	VI1865A0	5X10 TCB+ SELF-THREADI NG SCREW	1.000	PC	VI1870A0	50x50 SELF-THREADI NG SCREW FOR PLASTIC	1.000	PC													
Code	Description	Qty	UOM																															
GN1240A0	COLUMN-GLA SS BLACK SILICON SEAL	2.000	PC																															
VI1865A0	5X10 TCB+ SELF-THREADI NG SCREW	1.000	PC																															
VI1870A0	50x50 SELF-THREADI NG SCREW FOR PLASTIC	1.000	PC																															



COMPONENT			SPARE PART																																		
Code	Description	Image	Code	Description	Kit components																																
VM1375A	LEFT DOOR COLUMN L. MICRO ANNA		KVM1375A	XF023-XF043 LEFT DOOR COLUMN KIT	<table border="1"> <thead> <tr> <th>Code</th> <th>Description</th> <th>Qty</th> <th>UOM</th> </tr> </thead> <tbody> <tr> <td>VM1375A1</td> <td>H381 LMC LEFT DOOR COLUMN</td> <td>1.000</td> <td>PC</td> </tr> <tr> <td>VM1380B0</td> <td>L.MICRO GLASS-DOOR FIXING CAP</td> <td>1.000</td> <td>PC</td> </tr> <tr> <td>VP1752A0</td> <td>UPPER GLASS HOLDING PLATE</td> <td>1.000</td> <td>PC</td> </tr> <tr> <td>VP1753A0</td> <td>LOWER GLASS HOLDING PLATE</td> <td>1.000</td> <td>PC</td> </tr> </tbody> </table>	Code	Description	Qty	UOM	VM1375A1	H381 LMC LEFT DOOR COLUMN	1.000	PC	VM1380B0	L.MICRO GLASS-DOOR FIXING CAP	1.000	PC	VP1752A0	UPPER GLASS HOLDING PLATE	1.000	PC	VP1753A0	LOWER GLASS HOLDING PLATE	1.000	PC												
Code	Description	Qty	UOM																																		
VM1375A1	H381 LMC LEFT DOOR COLUMN	1.000	PC																																		
VM1380B0	L.MICRO GLASS-DOOR FIXING CAP	1.000	PC																																		
VP1752A0	UPPER GLASS HOLDING PLATE	1.000	PC																																		
VP1753A0	LOWER GLASS HOLDING PLATE	1.000	PC																																		
VM1376A	L. MICRO ANNA RIGHT DOOR COLUMN		KVM1376A	XF023-XF043 RIGHT DOOR COLUMN KIT	<table border="1"> <thead> <tr> <th>Code</th> <th>Description</th> <th>Qty</th> <th>UOM</th> </tr> </thead> <tbody> <tr> <td>GN1240A0</td> <td>COLUMN-GLA SS BLACK SILICON SEAL</td> <td>2.000</td> <td>PC</td> </tr> <tr> <td>VI1865A0</td> <td>5X10 TCB+ SELF-THREADI NG SCREW</td> <td>1.000</td> <td>PC</td> </tr> <tr> <td>VI1870A0</td> <td>50x50 SELF-THREADI NG SCREW FOR PLASTIC</td> <td>1.000</td> <td>PC</td> </tr> <tr> <td>VM1376A1</td> <td>H381 LMC RIGHT DOOR COLUMN</td> <td>1.000</td> <td>PC</td> </tr> <tr> <td>VM1380B0</td> <td>L.MICRO GLASS-DOOR FIXING CAP</td> <td>1.000</td> <td>PC</td> </tr> <tr> <td>VP1752A0</td> <td>UPPER GLASS HOLDING PLATE</td> <td>1.000</td> <td>PC</td> </tr> <tr> <td>VP1753A0</td> <td>LOWER GLASS HOLDING PLATE</td> <td>1.000</td> <td>PC</td> </tr> </tbody> </table>	Code	Description	Qty	UOM	GN1240A0	COLUMN-GLA SS BLACK SILICON SEAL	2.000	PC	VI1865A0	5X10 TCB+ SELF-THREADI NG SCREW	1.000	PC	VI1870A0	50x50 SELF-THREADI NG SCREW FOR PLASTIC	1.000	PC	VM1376A1	H381 LMC RIGHT DOOR COLUMN	1.000	PC	VM1380B0	L.MICRO GLASS-DOOR FIXING CAP	1.000	PC	VP1752A0	UPPER GLASS HOLDING PLATE	1.000	PC	VP1753A0	LOWER GLASS HOLDING PLATE	1.000	PC
Code	Description	Qty	UOM																																		
GN1240A0	COLUMN-GLA SS BLACK SILICON SEAL	2.000	PC																																		
VI1865A0	5X10 TCB+ SELF-THREADI NG SCREW	1.000	PC																																		
VI1870A0	50x50 SELF-THREADI NG SCREW FOR PLASTIC	1.000	PC																																		
VM1376A1	H381 LMC RIGHT DOOR COLUMN	1.000	PC																																		
VM1380B0	L.MICRO GLASS-DOOR FIXING CAP	1.000	PC																																		
VP1752A0	UPPER GLASS HOLDING PLATE	1.000	PC																																		
VP1753A0	LOWER GLASS HOLDING PLATE	1.000	PC																																		
VM1380B	L.MICRO GLASS-DOOR FIXING CAP		KVM1380B	LMICRO DOOR CAP 2 PCS KIT	<table border="1"> <thead> <tr> <th>Code</th> <th>Description</th> <th>Qty</th> <th>UOM</th> </tr> </thead> <tbody> <tr> <td>VI1865A0</td> <td>5X10 TCB+ SELF-THREADI NG SCREW</td> <td>2.000</td> <td>PC</td> </tr> <tr> <td>VM1380B0</td> <td>L.MICRO GLASS-DOOR FIXING CAP</td> <td>2.000</td> <td>PC</td> </tr> </tbody> </table>	Code	Description	Qty	UOM	VI1865A0	5X10 TCB+ SELF-THREADI NG SCREW	2.000	PC	VM1380B0	L.MICRO GLASS-DOOR FIXING CAP	2.000	PC																				
Code	Description	Qty	UOM																																		
VI1865A0	5X10 TCB+ SELF-THREADI NG SCREW	2.000	PC																																		
VM1380B0	L.MICRO GLASS-DOOR FIXING CAP	2.000	PC																																		



COMPONENT			SPARE PART																																																											
Code	Description	Image	Code	Description	Kit components																																																									
VT1155A	INTERNAL GLASS 512X362X4 LineMicro XF023		KVT1155A	LINEMICRO XF023 INTERNAL GLASS KI	<table border="1"> <thead> <tr> <th>Code</th> <th>Description</th> <th>Qty</th> <th>UOM</th> </tr> </thead> <tbody> <tr> <td>GN1240A0</td> <td>COLUMN-GLA SS BLACK SILICON SEAL</td> <td>4.000</td> <td>PC</td> </tr> <tr> <td>VT1155A0</td> <td>INTERNAL GLASS 512X362X4 LineMicro XF02</td> <td>1.000</td> <td>PC</td> </tr> </tbody> </table>	Code	Description	Qty	UOM	GN1240A0	COLUMN-GLA SS BLACK SILICON SEAL	4.000	PC	VT1155A0	INTERNAL GLASS 512X362X4 LineMicro XF02	1.000	PC																																													
			Code	Description	Qty	UOM																																																								
GN1240A0	COLUMN-GLA SS BLACK SILICON SEAL	4.000	PC																																																											
VT1155A0	INTERNAL GLASS 512X362X4 LineMicro XF02	1.000	PC																																																											
KDR1156A	LineMicro XF023 COMPLETE DOOR	<table border="1"> <thead> <tr> <th>Code</th> <th>Description</th> <th>Qty</th> <th>UOM</th> </tr> </thead> <tbody> <tr> <td>0H3195B0</td> <td>HANDLE TUBE L= 508 Ø18x1</td> <td>1.000</td> <td>PC</td> </tr> <tr> <td>CR1065A1</td> <td></td> <td>2.000</td> <td>PC</td> </tr> <tr> <td>GN1240A0</td> <td>COLUMN-GLA SS BLACK SILICON SEAL</td> <td>4.000</td> <td>PC</td> </tr> <tr> <td>MG1015B0</td> <td>L.MISS/L.MICR O/CHEFTOP HANDLE END</td> <td>2.000</td> <td>PC</td> </tr> <tr> <td>VI1280A3</td> <td>M5x10 TC1/2T SCREW</td> <td>6.000</td> <td>PC</td> </tr> <tr> <td>VI1865A0</td> <td>5X10 TCB+ SELF-THREADI NG SCREW</td> <td>2.000</td> <td>PC</td> </tr> <tr> <td>VI1870A0</td> <td>50x50 SELF-THREADI NG SCREW FOR PLASTIC</td> <td>2.000</td> <td>PC</td> </tr> <tr> <td>VM1375A1</td> <td>H381 LMC LEFT DOOR COLUMN</td> <td>1.000</td> <td>PC</td> </tr> <tr> <td>VM1376A1</td> <td>H381 LMC RIGHT DOOR COLUMN</td> <td>1.000</td> <td>PC</td> </tr> <tr> <td>VM1380B0</td> <td>L.MICRO GLASS-DOOR FIXING CAP</td> <td>2.000</td> <td>PC</td> </tr> <tr> <td>VP1752A0</td> <td>UPPER GLASS HOLDING PLATE</td> <td>2.000</td> <td>PC</td> </tr> <tr> <td>VP1753A0</td> <td>LOWER GLASS HOLDING PLATE</td> <td>2.000</td> <td>PC</td> </tr> <tr> <td>VT1155A0</td> <td>INTERNAL GLASS 512X362X4 LineMicro XF02</td> <td>1.000</td> <td>PC</td> </tr> <tr> <td>VT1156A1</td> <td>LineMicro XF023 590x382x4 EXTERNAL GLASS</td> <td>1.000</td> <td>PC</td> </tr> </tbody> </table>	Code	Description	Qty	UOM	0H3195B0	HANDLE TUBE L= 508 Ø18x1	1.000	PC	CR1065A1		2.000	PC	GN1240A0	COLUMN-GLA SS BLACK SILICON SEAL	4.000	PC	MG1015B0	L.MISS/L.MICR O/CHEFTOP HANDLE END	2.000	PC	VI1280A3	M5x10 TC1/2T SCREW	6.000	PC	VI1865A0	5X10 TCB+ SELF-THREADI NG SCREW	2.000	PC	VI1870A0	50x50 SELF-THREADI NG SCREW FOR PLASTIC	2.000	PC	VM1375A1	H381 LMC LEFT DOOR COLUMN	1.000	PC	VM1376A1	H381 LMC RIGHT DOOR COLUMN	1.000	PC	VM1380B0	L.MICRO GLASS-DOOR FIXING CAP	2.000	PC	VP1752A0	UPPER GLASS HOLDING PLATE	2.000	PC	VP1753A0	LOWER GLASS HOLDING PLATE	2.000	PC	VT1155A0	INTERNAL GLASS 512X362X4 LineMicro XF02	1.000	PC	VT1156A1	LineMicro XF023 590x382x4 EXTERNAL GLASS	1.000	PC
Code	Description	Qty	UOM																																																											
0H3195B0	HANDLE TUBE L= 508 Ø18x1	1.000	PC																																																											
CR1065A1		2.000	PC																																																											
GN1240A0	COLUMN-GLA SS BLACK SILICON SEAL	4.000	PC																																																											
MG1015B0	L.MISS/L.MICR O/CHEFTOP HANDLE END	2.000	PC																																																											
VI1280A3	M5x10 TC1/2T SCREW	6.000	PC																																																											
VI1865A0	5X10 TCB+ SELF-THREADI NG SCREW	2.000	PC																																																											
VI1870A0	50x50 SELF-THREADI NG SCREW FOR PLASTIC	2.000	PC																																																											
VM1375A1	H381 LMC LEFT DOOR COLUMN	1.000	PC																																																											
VM1376A1	H381 LMC RIGHT DOOR COLUMN	1.000	PC																																																											
VM1380B0	L.MICRO GLASS-DOOR FIXING CAP	2.000	PC																																																											
VP1752A0	UPPER GLASS HOLDING PLATE	2.000	PC																																																											
VP1753A0	LOWER GLASS HOLDING PLATE	2.000	PC																																																											
VT1155A0	INTERNAL GLASS 512X362X4 LineMicro XF02	1.000	PC																																																											
VT1156A1	LineMicro XF023 590x382x4 EXTERNAL GLASS	1.000	PC																																																											



COMPONENT			SPARE PART																																																											
Code	Description	Image	Code	Description	Kit components																																																									
VT1156A	LineMicro XF023 590x382x4 EXTERNAL GLASS		KVT1156A	LINEMICRO XF023 EXTERNAL GLASS KIT	<table border="1"> <thead> <tr> <th>Code</th> <th>Description</th> <th>Qty</th> <th>UOM</th> </tr> </thead> <tbody> <tr> <td>VT1156A1</td> <td>LineMicro XF023 590x382x4 EXTERNAL GLASS</td> <td>1.000</td> <td>PC</td> </tr> </tbody> </table>	Code	Description	Qty	UOM	VT1156A1	LineMicro XF023 590x382x4 EXTERNAL GLASS	1.000	PC																																																	
			Code	Description	Qty	UOM																																																								
VT1156A1	LineMicro XF023 590x382x4 EXTERNAL GLASS	1.000	PC																																																											
KDR1156A	LineMicro XF023 COMPLETE DOOR	<table border="1"> <thead> <tr> <th>Code</th> <th>Description</th> <th>Qty</th> <th>UOM</th> </tr> </thead> <tbody> <tr> <td>0H3195B0</td> <td>HANDLE TUBE L= 508 Ø18x1</td> <td>1.000</td> <td>PC</td> </tr> <tr> <td>CR1065A1</td> <td></td> <td>2.000</td> <td>PC</td> </tr> <tr> <td>GN1240A0</td> <td>COLUMN-GLA SS BLACK SILICON SEAL</td> <td>4.000</td> <td>PC</td> </tr> <tr> <td>MG1015B0</td> <td>L.MISS/L.MICR O/CHEFTOP HANDLE END</td> <td>2.000</td> <td>PC</td> </tr> <tr> <td>VI1280A3</td> <td>M5x10 TC1/2T SCREW</td> <td>6.000</td> <td>PC</td> </tr> <tr> <td>VI1865A0</td> <td>5X10 TCB+ SELF-THREADI NG SCREW</td> <td>2.000</td> <td>PC</td> </tr> <tr> <td>VI1870A0</td> <td>50x50 SELF-THREADI NG SCREW FOR PLASTIC</td> <td>2.000</td> <td>PC</td> </tr> <tr> <td>VM1375A1</td> <td>H381 LMC LEFT DOOR COLUMN</td> <td>1.000</td> <td>PC</td> </tr> <tr> <td>VM1376A1</td> <td>H381 LMC RIGHT DOOR COLUMN</td> <td>1.000</td> <td>PC</td> </tr> <tr> <td>VM1380B0</td> <td>L.MICRO GLASS-DOOR FIXING CAP</td> <td>2.000</td> <td>PC</td> </tr> <tr> <td>VP1752A0</td> <td>UPPER GLASS HOLDING PLATE</td> <td>2.000</td> <td>PC</td> </tr> <tr> <td>VP1753A0</td> <td>LOWER GLASS HOLDING PLATE</td> <td>2.000</td> <td>PC</td> </tr> <tr> <td>VT1155A0</td> <td>INTERNAL GLASS 512X362X4 LineMicro XF02</td> <td>1.000</td> <td>PC</td> </tr> <tr> <td>VT1156A1</td> <td>LineMicro XF023 590x382x4 EXTERNAL GLASS</td> <td>1.000</td> <td>PC</td> </tr> </tbody> </table>	Code	Description	Qty	UOM	0H3195B0	HANDLE TUBE L= 508 Ø18x1	1.000	PC	CR1065A1		2.000	PC	GN1240A0	COLUMN-GLA SS BLACK SILICON SEAL	4.000	PC	MG1015B0	L.MISS/L.MICR O/CHEFTOP HANDLE END	2.000	PC	VI1280A3	M5x10 TC1/2T SCREW	6.000	PC	VI1865A0	5X10 TCB+ SELF-THREADI NG SCREW	2.000	PC	VI1870A0	50x50 SELF-THREADI NG SCREW FOR PLASTIC	2.000	PC	VM1375A1	H381 LMC LEFT DOOR COLUMN	1.000	PC	VM1376A1	H381 LMC RIGHT DOOR COLUMN	1.000	PC	VM1380B0	L.MICRO GLASS-DOOR FIXING CAP	2.000	PC	VP1752A0	UPPER GLASS HOLDING PLATE	2.000	PC	VP1753A0	LOWER GLASS HOLDING PLATE	2.000	PC	VT1155A0	INTERNAL GLASS 512X362X4 LineMicro XF02	1.000	PC	VT1156A1	LineMicro XF023 590x382x4 EXTERNAL GLASS	1.000	PC
Code	Description	Qty	UOM																																																											
0H3195B0	HANDLE TUBE L= 508 Ø18x1	1.000	PC																																																											
CR1065A1		2.000	PC																																																											
GN1240A0	COLUMN-GLA SS BLACK SILICON SEAL	4.000	PC																																																											
MG1015B0	L.MISS/L.MICR O/CHEFTOP HANDLE END	2.000	PC																																																											
VI1280A3	M5x10 TC1/2T SCREW	6.000	PC																																																											
VI1865A0	5X10 TCB+ SELF-THREADI NG SCREW	2.000	PC																																																											
VI1870A0	50x50 SELF-THREADI NG SCREW FOR PLASTIC	2.000	PC																																																											
VM1375A1	H381 LMC LEFT DOOR COLUMN	1.000	PC																																																											
VM1376A1	H381 LMC RIGHT DOOR COLUMN	1.000	PC																																																											
VM1380B0	L.MICRO GLASS-DOOR FIXING CAP	2.000	PC																																																											
VP1752A0	UPPER GLASS HOLDING PLATE	2.000	PC																																																											
VP1753A0	LOWER GLASS HOLDING PLATE	2.000	PC																																																											
VT1155A0	INTERNAL GLASS 512X362X4 LineMicro XF02	1.000	PC																																																											
VT1156A1	LineMicro XF023 590x382x4 EXTERNAL GLASS	1.000	PC																																																											

**ASM1520A/0.D03 - - FRONT**

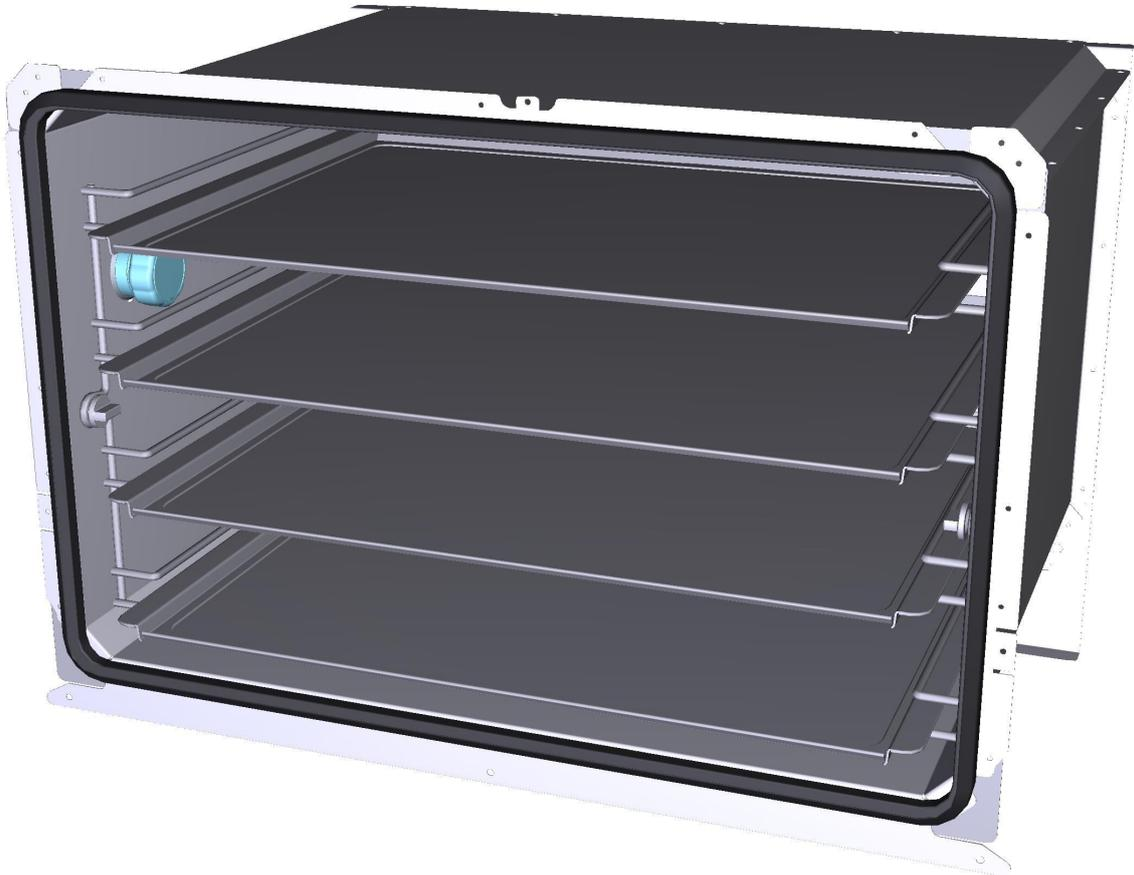

ASM1520A/0.D03 - - REAR

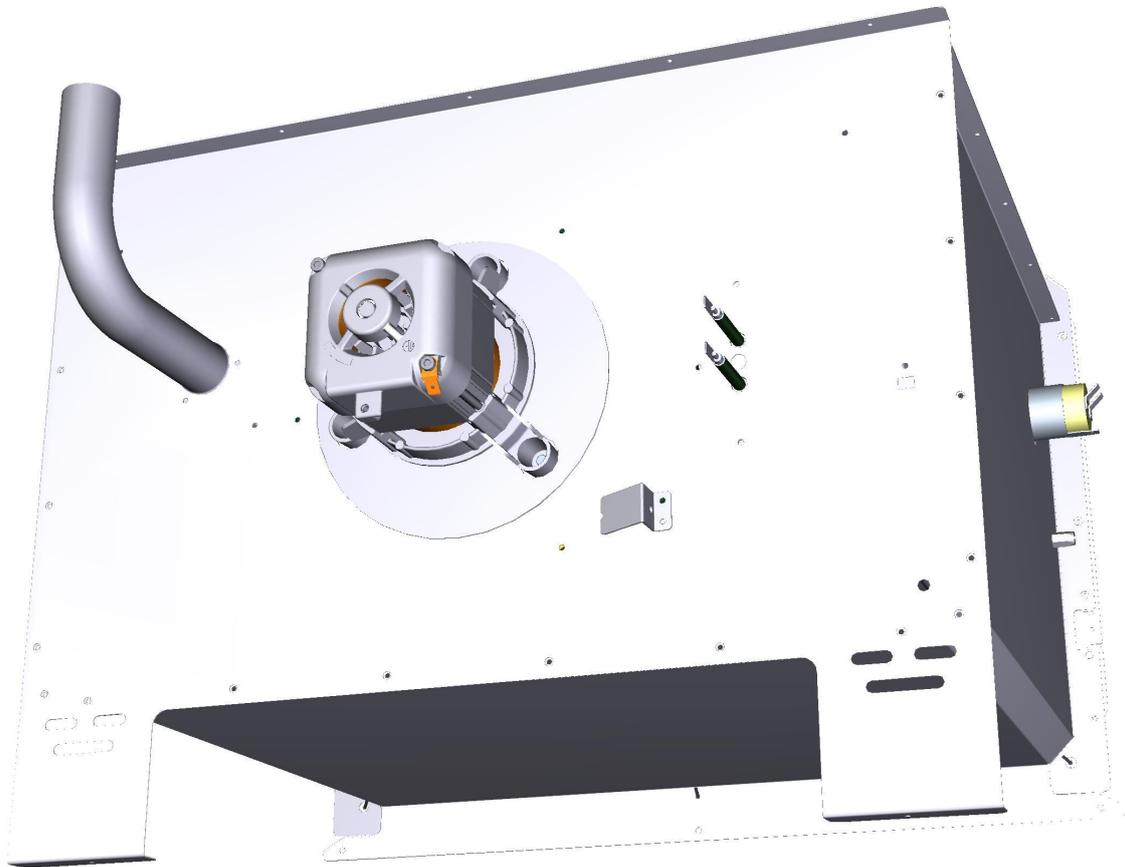

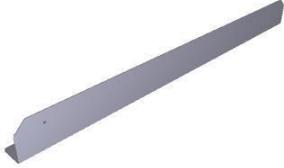

COMPONENT			SPARE PART														
Code	Description	Image	Code	Description	Kit components												
0G1231A	XF023 TAINLESS STEEL FAN GUARD SPACER		0G1231A0	XF023 TAINLESS STEEL FAN GUARD SPACER													
0G1531A	ST.STEEL FAN GUARD OCT. XF023		0G1531A1	ST.STEEL FAN GUARD OCT. XF023													
0G1532A	FAN GUARD SPACER OCT. XF023		0G1532A0	FAN GUARD SPACER OCT. XF023													
0H3020A	MOTOR SHAFT SEALING DISC		K0H3020A	CRANKSHAFT SEAL DISC	<table border="1"> <thead> <tr> <th>Code</th> <th>Description</th> <th>Qty</th> <th>UOM</th> </tr> </thead> <tbody> <tr> <td>0H3020A1</td> <td>MOTOR SHAFT SEALING DISC</td> <td>1.000</td> <td>PC</td> </tr> <tr> <td>GN1546A0</td> <td>SHAFT GASKET D8</td> <td>1.000</td> <td>PC</td> </tr> </tbody> </table>	Code	Description	Qty	UOM	0H3020A1	MOTOR SHAFT SEALING DISC	1.000	PC	GN1546A0	SHAFT GASKET D8	1.000	PC
Code	Description	Qty	UOM														
0H3020A1	MOTOR SHAFT SEALING DISC	1.000	PC														
GN1546A0	SHAFT GASKET D8	1.000	PC														
0H3590A	SAFETY THERMOSTAT BULB FASTENER		0H3590A1	SAFETY THERMOSTAT BULB FASTENER													

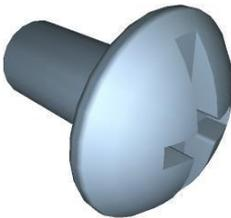

COMPONENT			SPARE PART																						
Code	Description	Image	Code	Description	Kit components																				
0H4820A	BULB HOLDING BRACKET		0H4820A1	BULB HOLDING BRACKET																					
0H6910A	OCTAGONAL XF OVENS PLATE COVER		0H6910A0	OCTAGONAL XF OVENS PLATE COVER																					
0H3585A	ZINCED MOTOR GUARD PLATE L.M.		0H3585A0	ZINCED MOTOR GUARD PLATE L.M.																					
VI1785A	CHROMIUM PLATED BRASS SCREW M6x12		KVI1785A	KIT VITE M6X12 ROTOR 20 PZ	<table border="1"> <thead> <tr> <th>Code</th> <th>Description</th> <th>Qty</th> <th>UOM</th> </tr> </thead> <tbody> <tr> <td>VI1300A0</td> <td>SCREW M6X12 T1/2T+INOX</td> <td>20.000</td> <td>PC</td> </tr> </tbody> </table>	Code	Description	Qty	UOM	VI1300A0	SCREW M6X12 T1/2T+INOX	20.000	PC												
Code	Description	Qty	UOM																						
VI1300A0	SCREW M6X12 T1/2T+INOX	20.000	PC																						
VN1035B	LINE MISS 230 VAC MOTOR		KVN1035B	LINEMISS / LINEMICRO MOTOR KIT	<table border="1"> <thead> <tr> <th>Code</th> <th>Description</th> <th>Qty</th> <th>UOM</th> </tr> </thead> <tbody> <tr> <td>GN1270A0</td> <td>13x5.5x0.8 FLAT WASHER</td> <td>3.000</td> <td>PC</td> </tr> <tr> <td>GN1546A0</td> <td>SHAFT GASKET D8</td> <td>1.000</td> <td>PC</td> </tr> <tr> <td>VI1695A0</td> <td>M6x16 H6 CH10 STAINLESS STEEL NUT</td> <td>1.000</td> <td>PC</td> </tr> <tr> <td>VI1700A0</td> <td>18x6.4x1.5 STAINLESS STEEL FLAT WASHER</td> <td>1.000</td> <td>PC</td> </tr> </tbody> </table>	Code	Description	Qty	UOM	GN1270A0	13x5.5x0.8 FLAT WASHER	3.000	PC	GN1546A0	SHAFT GASKET D8	1.000	PC	VI1695A0	M6x16 H6 CH10 STAINLESS STEEL NUT	1.000	PC	VI1700A0	18x6.4x1.5 STAINLESS STEEL FLAT WASHER	1.000	PC
Code	Description	Qty	UOM																						
GN1270A0	13x5.5x0.8 FLAT WASHER	3.000	PC																						
GN1546A0	SHAFT GASKET D8	1.000	PC																						
VI1695A0	M6x16 H6 CH10 STAINLESS STEEL NUT	1.000	PC																						
VI1700A0	18x6.4x1.5 STAINLESS STEEL FLAT WASHER	1.000	PC																						

COMPONENT			SPARE PART																						
Code	Description	Image	Code	Description	Kit components																				
VN1035B	LINE MISS 230 VAC MOTOR		KVN1035B	LINEMISS / LINEMICRO MOTOR KIT	<table border="1"> <thead> <tr> <th>Code</th> <th>Description</th> <th>Qty</th> <th>UOM</th> </tr> </thead> <tbody> <tr> <td>V11836A0</td> <td>M6x12 OT63 HEX HEAD SMOOTH FLANGE SCREW</td> <td>3.000</td> <td>PC</td> </tr> <tr> <td>VN1035B1</td> <td>LINE MISS 230 VAC MOTOR</td> <td>1.000</td> <td>PC</td> </tr> </tbody> </table>	Code	Description	Qty	UOM	V11836A0	M6x12 OT63 HEX HEAD SMOOTH FLANGE SCREW	3.000	PC	VN1035B1	LINE MISS 230 VAC MOTOR	1.000	PC								
Code	Description	Qty	UOM																						
V11836A0	M6x12 OT63 HEX HEAD SMOOTH FLANGE SCREW	3.000	PC																						
VN1035B1	LINE MISS 230 VAC MOTOR	1.000	PC																						
VN1050A	D=196 H=32 38 BLADES STAINLESS STEEL FAN		KVN1050A	D196 H32 FAN KIT	<table border="1"> <thead> <tr> <th>Code</th> <th>Description</th> <th>Qty</th> <th>UOM</th> </tr> </thead> <tbody> <tr> <td>V11695A0</td> <td>M6x16 H6 CH10 STAINLESS STEEL NUT</td> <td>1.000</td> <td>PC</td> </tr> <tr> <td>V11700A0</td> <td>18x6.4x1.5 STAINLESS STEEL FLAT WASHER</td> <td>1.000</td> <td>PC</td> </tr> <tr> <td>VN1050A2</td> <td>D=196 H=32 38 BLADES STAINLESS STEEL FAN</td> <td>1.000</td> <td>PC</td> </tr> </tbody> </table>	Code	Description	Qty	UOM	V11695A0	M6x16 H6 CH10 STAINLESS STEEL NUT	1.000	PC	V11700A0	18x6.4x1.5 STAINLESS STEEL FLAT WASHER	1.000	PC	VN1050A2	D=196 H=32 38 BLADES STAINLESS STEEL FAN	1.000	PC				
Code	Description	Qty	UOM																						
V11695A0	M6x16 H6 CH10 STAINLESS STEEL NUT	1.000	PC																						
V11700A0	18x6.4x1.5 STAINLESS STEEL FLAT WASHER	1.000	PC																						
VN1050A2	D=196 H=32 38 BLADES STAINLESS STEEL FAN	1.000	PC																						
RS1130A	D=230 3 TURNS 2900W HEATING ELEMENT		KRS1130A	2900W 230V HEATING ELEMENT KIT	<table border="1"> <thead> <tr> <th>Code</th> <th>Description</th> <th>Qty</th> <th>UOM</th> </tr> </thead> <tbody> <tr> <td>GN1327A0</td> <td>HEATING ELEMENT GASKET</td> <td>1.000</td> <td>PC</td> </tr> <tr> <td>RS1130A0</td> <td>D=230 3 TURNS 2900W HEATING ELEMENT</td> <td>1.000</td> <td>PC</td> </tr> <tr> <td>SL1045A0</td> <td>S57 BLACK SILICONE - 80ml CARTRIDGE</td> <td>1.000</td> <td>PC</td> </tr> <tr> <td>V11220A1</td> <td>4,2x12 TCB SELF-TAPPIN G SCREW</td> <td>5.000</td> <td>PC</td> </tr> </tbody> </table>	Code	Description	Qty	UOM	GN1327A0	HEATING ELEMENT GASKET	1.000	PC	RS1130A0	D=230 3 TURNS 2900W HEATING ELEMENT	1.000	PC	SL1045A0	S57 BLACK SILICONE - 80ml CARTRIDGE	1.000	PC	V11220A1	4,2x12 TCB SELF-TAPPIN G SCREW	5.000	PC
Code	Description	Qty	UOM																						
GN1327A0	HEATING ELEMENT GASKET	1.000	PC																						
RS1130A0	D=230 3 TURNS 2900W HEATING ELEMENT	1.000	PC																						
SL1045A0	S57 BLACK SILICONE - 80ml CARTRIDGE	1.000	PC																						
V11220A1	4,2x12 TCB SELF-TAPPIN G SCREW	5.000	PC																						
GN1140A	MOTOR HOLDER GASKET		KG1140A	5 PCS. MOTOR HOLDER GASKET KI	<table border="1"> <thead> <tr> <th>Code</th> <th>Description</th> <th>Qty</th> <th>UOM</th> </tr> </thead> <tbody> <tr> <td>GN1140A3</td> <td>MOLDED MOTOR HOLDER GASKET</td> <td>5.000</td> <td>PC</td> </tr> </tbody> </table>	Code	Description	Qty	UOM	GN1140A3	MOLDED MOTOR HOLDER GASKET	5.000	PC												
Code	Description	Qty	UOM																						
GN1140A3	MOLDED MOTOR HOLDER GASKET	5.000	PC																						

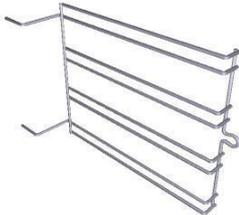
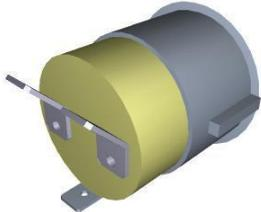
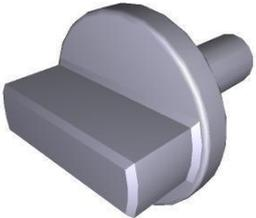
COMPONENT			SPARE PART										
Code	Description	Image	Code	Description	Kit components								
GN1235A	LineMicro ANNA XF023 DOOR GASKE		KGN1235B	LineMicro ANNA XF023 DOOR GASKET KIT	<table border="1"> <thead> <tr> <th>Code</th> <th>Description</th> <th>Qty</th> <th>UOM</th> </tr> </thead> <tbody> <tr> <td>GN1235B0</td> <td>LineMicro ANNA XF023 6 HOOKS DOOR GASKET</td> <td>1.000</td> <td>PC</td> </tr> </tbody> </table>	Code	Description	Qty	UOM	GN1235B0	LineMicro ANNA XF023 6 HOOKS DOOR GASKET	1.000	PC
			Code	Description	Qty	UOM							
GN1235B0	LineMicro ANNA XF023 6 HOOKS DOOR GASKET	1.000	PC										
KGN0031B	LM ANNA CADCO 100PCS DOOR GASKET KIT	<table border="1"> <thead> <tr> <th>Code</th> <th>Description</th> <th>Qty</th> <th>UOM</th> </tr> </thead> <tbody> <tr> <td>GN1235B0</td> <td>LineMicro ANNA XF023 6 HOOKS DOOR GASKET</td> <td>100.000</td> <td>PC</td> </tr> </tbody> </table>	Code	Description	Qty	UOM	GN1235B0	LineMicro ANNA XF023 6 HOOKS DOOR GASKET	100.000	PC			
Code	Description	Qty	UOM										
GN1235B0	LineMicro ANNA XF023 6 HOOKS DOOR GASKET	100.000	PC										
GRL1090B	XF023 R/L 4 75 PITCH LAT. SUPPOR		KGRL1090B	XF023 R/L 460x330 LATERAL SUPPORT KIT	<table border="1"> <thead> <tr> <th>Code</th> <th>Description</th> <th>Qty</th> <th>UOM</th> </tr> </thead> <tbody> <tr> <td>GRL1090B0</td> <td>XF023 R/L 4 75 PITCH LAT. SUPPORT</td> <td>2.000</td> <td>PC</td> </tr> </tbody> </table>	Code	Description	Qty	UOM	GRL1090B0	XF023 R/L 4 75 PITCH LAT. SUPPORT	2.000	PC
Code	Description	Qty	UOM										
GRL1090B0	XF023 R/L 4 75 PITCH LAT. SUPPORT	2.000	PC										
TB2092A	LINE MICRO EXHAUST CHIMNEY		TB2092A0	LINE MICRO EXHAUST CHIMNEY									
VE1480A	230V-25W LAMP SET		KVE1480A	L.MICRO LAMP KIT 230V-25W	<table border="1"> <thead> <tr> <th>Code</th> <th>Description</th> <th>Qty</th> <th>UOM</th> </tr> </thead> <tbody> <tr> <td>VE1148A0</td> <td></td> <td>1.000</td> <td>PC</td> </tr> </tbody> </table>	Code	Description	Qty	UOM	VE1148A0		1.000	PC
Code	Description	Qty	UOM										
VE1148A0		1.000	PC										
VM1815A	LATERAL SUPPORTS FIXING BOLT		KVM1815A	MISS/MICRO/S4/S3 THUMB SCREW 10 PCS KIT	<table border="1"> <thead> <tr> <th>Code</th> <th>Description</th> <th>Qty</th> <th>UOM</th> </tr> </thead> <tbody> <tr> <td>VM1815A0</td> <td>LATERAL SUPPORTS FIXING BOLT</td> <td>10.000</td> <td>PC</td> </tr> </tbody> </table>	Code	Description	Qty	UOM	VM1815A0	LATERAL SUPPORTS FIXING BOLT	10.000	PC
Code	Description	Qty	UOM										
VM1815A0	LATERAL SUPPORTS FIXING BOLT	10.000	PC										

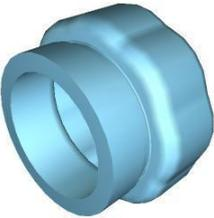

COMPONENT			SPARE PART										
<i>Code</i>	<i>Description</i>	<i>Image</i>	<i>Code</i>	<i>Description</i>	<i>Kit components</i>								
VT1200A	L.MICRO LAMP COVER BOROSILICATE GLASS		KVT1200A	GLASS LAMP COVER KIT	<table border="1"> <thead> <tr> <th><i>Code</i></th> <th><i>Description</i></th> <th><i>Qty</i></th> <th><i>UOM</i></th> </tr> </thead> <tbody> <tr> <td>VT1200A1</td> <td></td> <td>1.000</td> <td>PC</td> </tr> </tbody> </table>	<i>Code</i>	<i>Description</i>	<i>Qty</i>	<i>UOM</i>	VT1200A1		1.000	PC
<i>Code</i>	<i>Description</i>	<i>Qty</i>	<i>UOM</i>										
VT1200A1		1.000	PC										

ASM1521A/0.D01 - - FRONT



ASM1521A/0.D01 - - REAR





COMPONENT			SPARE PART																										
Code	Description	Image	Code	Description	Kit components																								
0D2232A	LINEMICRO XF023 OUTER CASING		0D2232A0	LINEMICRO XF023 OUTER CASING																									
0E1175B	L.MICRO LISA-ANNA EXTERNAL BOTTOM PANEL		0E1175B1	L.MICRO LISA-ANNA EXTERNAL BOTTOM PANEL																									
0F1422A	LINEMICRO XF023 IP BACK PANEL		KVM0002A	ANNA BACK PLASTIC DRIP FLAP KIT	<table border="1"> <thead> <tr> <th>Code</th> <th>Description</th> <th>Qty</th> <th>UOM</th> </tr> </thead> <tbody> <tr> <td>0F1422A1</td> <td>LINEMICRO XF023 IP BACK PANEL</td> <td>1.000</td> <td>PC</td> </tr> <tr> <td>VM1950A2</td> <td>WATER PROTECTION DRIP FLAP</td> <td>1.000</td> <td>PC</td> </tr> </tbody> </table>	Code	Description	Qty	UOM	0F1422A1	LINEMICRO XF023 IP BACK PANEL	1.000	PC	VM1950A2	WATER PROTECTION DRIP FLAP	1.000	PC												
Code	Description	Qty	UOM																										
0F1422A1	LINEMICRO XF023 IP BACK PANEL	1.000	PC																										
VM1950A2	WATER PROTECTION DRIP FLAP	1.000	PC																										
ED1070A	78x33 UNOX LOGO STICKER		KED1070A	UNOX LOGO STICKER 10 PCS. KI																									
VE1530A	GOLD THERMOMETER BLUE LIGHT COVER		KLP1012A	GOLDEN THERMOMETER BLUE LIGHT KIT	<table border="1"> <thead> <tr> <th>Code</th> <th>Description</th> <th>Qty</th> <th>UOM</th> </tr> </thead> <tbody> <tr> <td>VE1170A0</td> <td>D16 OPAQUE NICKEL ELLIPTICAL SUPPORT</td> <td>1.000</td> <td>PC</td> </tr> <tr> <td>VE1530A0</td> <td>GOLD THERMOMETE R BLUE LIGHT COVER</td> <td>1.000</td> <td>PC</td> </tr> <tr> <td>VE1535A1</td> <td>230V WHITE LED</td> <td>1.000</td> <td>PC</td> </tr> <tr> <td>VM1782A0</td> <td>INNER LAMP SUPPORT</td> <td>1.000</td> <td>PC</td> </tr> <tr> <td>VM2009A0</td> <td>D16 SILVER ELLIPTICAL SUPPORT</td> <td>1.000</td> <td>PC</td> </tr> </tbody> </table>	Code	Description	Qty	UOM	VE1170A0	D16 OPAQUE NICKEL ELLIPTICAL SUPPORT	1.000	PC	VE1530A0	GOLD THERMOMETE R BLUE LIGHT COVER	1.000	PC	VE1535A1	230V WHITE LED	1.000	PC	VM1782A0	INNER LAMP SUPPORT	1.000	PC	VM2009A0	D16 SILVER ELLIPTICAL SUPPORT	1.000	PC
Code	Description	Qty	UOM																										
VE1170A0	D16 OPAQUE NICKEL ELLIPTICAL SUPPORT	1.000	PC																										
VE1530A0	GOLD THERMOMETE R BLUE LIGHT COVER	1.000	PC																										
VE1535A1	230V WHITE LED	1.000	PC																										
VM1782A0	INNER LAMP SUPPORT	1.000	PC																										
VM2009A0	D16 SILVER ELLIPTICAL SUPPORT	1.000	PC																										



COMPONENT			SPARE PART																			
Code	Description	Image	Code	Description	Kit components																	
VE1535A	230V WHITE LED		KVE1535A	230V WHITE LED LIGHT 1 PC KIT	<table border="1"> <thead> <tr> <th>Code</th> <th>Description</th> <th>Qty</th> <th>UOM</th> </tr> </thead> <tbody> <tr> <td>VE1535A1</td> <td>230V WHITE LED</td> <td>1.000</td> <td>PC</td> </tr> </tbody> </table>	Code	Description	Qty	UOM	VE1535A1	230V WHITE LED	1.000	PC									
			Code	Description	Qty	UOM																
			VE1535A1	230V WHITE LED	1.000	PC																
			KVE0105A	CLOUD LED LIGHT+COVER+SUPPORT KIT	<table border="1"> <thead> <tr> <th>Code</th> <th>Description</th> <th>Qty</th> <th>UOM</th> </tr> </thead> <tbody> <tr> <td>VE1170A0</td> <td>D16 OPAQUE NICKEL ELLIPTICAL SUPPORT</td> <td>1.000</td> <td>PC</td> </tr> <tr> <td>VE1535A1</td> <td>230V WHITE LED</td> <td>1.000</td> <td>PC</td> </tr> <tr> <td>VM1762A0</td> <td>INNER LAMP SUPPORT</td> <td>1.000</td> <td>PC</td> </tr> <tr> <td>VM1903A0</td> <td>GREEN PILOT WITH GOLD "CLOUD"</td> <td>1.000</td> <td>PC</td> </tr> </tbody> </table>	Code	Description	Qty	UOM	VE1170A0	D16 OPAQUE NICKEL ELLIPTICAL SUPPORT	1.000	PC	VE1535A1	230V WHITE LED	1.000	PC	VM1762A0	INNER LAMP SUPPORT	1.000	PC	VM1903A0
Code	Description	Qty	UOM																			
VE1170A0	D16 OPAQUE NICKEL ELLIPTICAL SUPPORT	1.000	PC																			
VE1535A1	230V WHITE LED	1.000	PC																			
VM1762A0	INNER LAMP SUPPORT	1.000	PC																			
VM1903A0	GREEN PILOT WITH GOLD "CLOUD"	1.000	PC																			
KVE0104A	NEUTRAL GREEN LIGHT KIT	<table border="1"> <thead> <tr> <th>Code</th> <th>Description</th> <th>Qty</th> <th>UOM</th> </tr> </thead> <tbody> <tr> <td>VE1170A0</td> <td>D16 OPAQUE NICKEL ELLIPTICAL SUPPORT</td> <td>1.000</td> <td>PC</td> </tr> <tr> <td>VE1535A1</td> <td>230V WHITE LED</td> <td>1.000</td> <td>PC</td> </tr> <tr> <td>VM1762A0</td> <td>INNER LAMP SUPPORT</td> <td>1.000</td> <td>PC</td> </tr> <tr> <td>VM1902A0</td> <td>NEUTRAL GREEN PLASTIC COVER FOR</td> <td>1.000</td> <td>PC</td> </tr> </tbody> </table>	Code	Description	Qty	UOM	VE1170A0	D16 OPAQUE NICKEL ELLIPTICAL SUPPORT	1.000	PC	VE1535A1	230V WHITE LED	1.000	PC	VM1762A0	INNER LAMP SUPPORT	1.000	PC	VM1902A0	NEUTRAL GREEN PLASTIC COVER FOR	1.000	PC
Code	Description	Qty	UOM																			
VE1170A0	D16 OPAQUE NICKEL ELLIPTICAL SUPPORT	1.000	PC																			
VE1535A1	230V WHITE LED	1.000	PC																			
VM1762A0	INNER LAMP SUPPORT	1.000	PC																			
VM1902A0	NEUTRAL GREEN PLASTIC COVER FOR	1.000	PC																			
KVE0102A	GOLDEN FLAME LIGHT COVER KIT	<table border="1"> <thead> <tr> <th>Code</th> <th>Description</th> <th>Qty</th> <th>UOM</th> </tr> </thead> <tbody> <tr> <td>VE1170A0</td> <td>D16 OPAQUE NICKEL ELLIPTICAL SUPPORT</td> <td>1.000</td> <td>PC</td> </tr> <tr> <td>VE1535A1</td> <td>230V WHITE LED</td> <td>1.000</td> <td>PC</td> </tr> <tr> <td>VM1762A0</td> <td>INNER LAMP SUPPORT</td> <td>1.000</td> <td>PC</td> </tr> <tr> <td>VM1767A0</td> <td>GREEN PILOT LIGHT W/ GOLD FLAME</td> <td>1.000</td> <td>PC</td> </tr> </tbody> </table>	Code	Description	Qty	UOM	VE1170A0	D16 OPAQUE NICKEL ELLIPTICAL SUPPORT	1.000	PC	VE1535A1	230V WHITE LED	1.000	PC	VM1762A0	INNER LAMP SUPPORT	1.000	PC	VM1767A0	GREEN PILOT LIGHT W/ GOLD FLAME	1.000	PC
Code	Description	Qty	UOM																			
VE1170A0	D16 OPAQUE NICKEL ELLIPTICAL SUPPORT	1.000	PC																			
VE1535A1	230V WHITE LED	1.000	PC																			
VM1762A0	INNER LAMP SUPPORT	1.000	PC																			
VM1767A0	GREEN PILOT LIGHT W/ GOLD FLAME	1.000	PC																			
KVE0101A	SINUSOID LIGHT GREEN COVER KIT	<table border="1"> <thead> <tr> <th>Code</th> <th>Description</th> <th>Qty</th> <th>UOM</th> </tr> </thead> <tbody> <tr> <td>VE1170A0</td> <td>D16 OPAQUE NICKEL ELLIPTICAL SUPPORT</td> <td>1.000</td> <td>PC</td> </tr> <tr> <td>VE1535A1</td> <td>230V WHITE LED</td> <td>1.000</td> <td>PC</td> </tr> <tr> <td>VM1762A0</td> <td>INNER LAMP SUPPORT</td> <td>1.000</td> <td>PC</td> </tr> <tr> <td>VM1765A0</td> <td>GREEN PILOT WITH GOLD SINUSOIDE</td> <td>1.000</td> <td>PC</td> </tr> </tbody> </table>	Code	Description	Qty	UOM	VE1170A0	D16 OPAQUE NICKEL ELLIPTICAL SUPPORT	1.000	PC	VE1535A1	230V WHITE LED	1.000	PC	VM1762A0	INNER LAMP SUPPORT	1.000	PC	VM1765A0	GREEN PILOT WITH GOLD SINUSOIDE	1.000	PC
Code	Description	Qty	UOM																			
VE1170A0	D16 OPAQUE NICKEL ELLIPTICAL SUPPORT	1.000	PC																			
VE1535A1	230V WHITE LED	1.000	PC																			
VM1762A0	INNER LAMP SUPPORT	1.000	PC																			
VM1765A0	GREEN PILOT WITH GOLD SINUSOIDE	1.000	PC																			



COMPONENT			SPARE PART																																			
Code	Description	Image	Code	Description	Kit components																																	
VE1535A	230V WHITE LED		KVE0100A	THERMOMETER LIGHT COVER KIT	<table border="1"> <thead> <tr> <th>Code</th> <th>Description</th> <th>Qty</th> <th>UOM</th> </tr> </thead> <tbody> <tr> <td>VE1530A0</td> <td>GOLD THERMOMETE R BLUE LIGHT COVER</td> <td>1.000</td> <td>PC</td> </tr> <tr> <td>VE1535A1</td> <td>230V WHITE LED</td> <td>1.000</td> <td>PC</td> </tr> <tr> <td>VM1761A0</td> <td>D16 BLACK ELLIPTICAL SUPPORT</td> <td>1.000</td> <td>PC</td> </tr> <tr> <td>VM1762A0</td> <td>INNER LAMP SUPPORT</td> <td>1.000</td> <td>PC</td> </tr> </tbody> </table>	Code	Description	Qty	UOM	VE1530A0	GOLD THERMOMETE R BLUE LIGHT COVER	1.000	PC	VE1535A1	230V WHITE LED	1.000	PC	VM1761A0	D16 BLACK ELLIPTICAL SUPPORT	1.000	PC	VM1762A0	INNER LAMP SUPPORT	1.000	PC													
			Code	Description	Qty	UOM																																
			VE1530A0	GOLD THERMOMETE R BLUE LIGHT COVER	1.000	PC																																
VE1535A1	230V WHITE LED	1.000	PC																																			
VM1761A0	D16 BLACK ELLIPTICAL SUPPORT	1.000	PC																																			
VM1762A0	INNER LAMP SUPPORT	1.000	PC																																			
KVE0011A	SP KNOBS AND LIGHTS KIT	<table border="1"> <thead> <tr> <th>Code</th> <th>Description</th> <th>Qty</th> <th>UOM</th> </tr> </thead> <tbody> <tr> <td>MN1105A0</td> <td>120-400C XP THERMOSTAT KNOB</td> <td>1.000</td> <td>PC</td> </tr> <tr> <td>MN1110A0</td> <td>XP NEUTRAL INDEX DIAL</td> <td>1.000</td> <td>PC</td> </tr> <tr> <td>VE1530A0</td> <td>GOLD THERMOMETE R BLUE LIGHT COVER</td> <td>1.000</td> <td>PC</td> </tr> <tr> <td>VE1535A1</td> <td>230V WHITE LED</td> <td>1.000</td> <td>PC</td> </tr> <tr> <td>VE1561A0</td> <td>NA/NA BIPOLAR SWITCH</td> <td>1.000</td> <td>PC</td> </tr> <tr> <td>VM1761A0</td> <td>D16 BLACK ELLIPTICAL SUPPORT</td> <td>2.000</td> <td>PC</td> </tr> <tr> <td>VM1762A0</td> <td>INNER LAMP SUPPORT</td> <td>1.000</td> <td>PC</td> </tr> <tr> <td>VM1776A0</td> <td>"GOLD "0-1" MATT SILVER KEY"</td> <td>1.000</td> <td>PC</td> </tr> </tbody> </table>	Code	Description	Qty	UOM	MN1105A0	120-400C XP THERMOSTAT KNOB	1.000	PC	MN1110A0	XP NEUTRAL INDEX DIAL	1.000	PC	VE1530A0	GOLD THERMOMETE R BLUE LIGHT COVER	1.000	PC	VE1535A1	230V WHITE LED	1.000	PC	VE1561A0	NA/NA BIPOLAR SWITCH	1.000	PC	VM1761A0	D16 BLACK ELLIPTICAL SUPPORT	2.000	PC	VM1762A0	INNER LAMP SUPPORT	1.000	PC	VM1776A0	"GOLD "0-1" MATT SILVER KEY"	1.000	PC
Code	Description	Qty	UOM																																			
MN1105A0	120-400C XP THERMOSTAT KNOB	1.000	PC																																			
MN1110A0	XP NEUTRAL INDEX DIAL	1.000	PC																																			
VE1530A0	GOLD THERMOMETE R BLUE LIGHT COVER	1.000	PC																																			
VE1535A1	230V WHITE LED	1.000	PC																																			
VE1561A0	NA/NA BIPOLAR SWITCH	1.000	PC																																			
VM1761A0	D16 BLACK ELLIPTICAL SUPPORT	2.000	PC																																			
VM1762A0	INNER LAMP SUPPORT	1.000	PC																																			
VM1776A0	"GOLD "0-1" MATT SILVER KEY"	1.000	PC																																			
KVE0008A	XL PILOT BLUE LIGHTS KIT	<table border="1"> <thead> <tr> <th>Code</th> <th>Description</th> <th>Qty</th> <th>UOM</th> </tr> </thead> <tbody> <tr> <td>VE1170A0</td> <td>D16 OPAQUE NICKEL ELLIPTICAL SUPPORT</td> <td>3.000</td> <td>PC</td> </tr> <tr> <td>VE1530A0</td> <td>GOLD THERMOMETE R BLUE LIGHT COVER</td> <td>1.000</td> <td>PC</td> </tr> <tr> <td>VE1535A1</td> <td>230V WHITE LED</td> <td>1.000</td> <td>PC</td> </tr> <tr> <td>VE1561A0</td> <td>NA/NA BIPOLAR SWITCH</td> <td>1.000</td> <td>PC</td> </tr> <tr> <td>VE1562A0</td> <td>UNIPOLAR NA PUSH BUTTO</td> <td>1.000</td> <td>PC</td> </tr> <tr> <td>VM1762A0</td> <td>INNER LAMP SUPPORT</td> <td>1.000</td> <td>PC</td> </tr> </tbody> </table>	Code	Description	Qty	UOM	VE1170A0	D16 OPAQUE NICKEL ELLIPTICAL SUPPORT	3.000	PC	VE1530A0	GOLD THERMOMETE R BLUE LIGHT COVER	1.000	PC	VE1535A1	230V WHITE LED	1.000	PC	VE1561A0	NA/NA BIPOLAR SWITCH	1.000	PC	VE1562A0	UNIPOLAR NA PUSH BUTTO	1.000	PC	VM1762A0	INNER LAMP SUPPORT	1.000	PC								
Code	Description	Qty	UOM																																			
VE1170A0	D16 OPAQUE NICKEL ELLIPTICAL SUPPORT	3.000	PC																																			
VE1530A0	GOLD THERMOMETE R BLUE LIGHT COVER	1.000	PC																																			
VE1535A1	230V WHITE LED	1.000	PC																																			
VE1561A0	NA/NA BIPOLAR SWITCH	1.000	PC																																			
VE1562A0	UNIPOLAR NA PUSH BUTTO	1.000	PC																																			
VM1762A0	INNER LAMP SUPPORT	1.000	PC																																			



COMPONENT			SPARE PART																																															
Code	Description	Image	Code	Description	Kit components																																													
VE1535A	230V WHITE LED		KVE0008A	XL PILOT BLUE LIGHTS KIT	<table border="1"> <thead> <tr> <th>Code</th> <th>Description</th> <th>Qty</th> <th>UOM</th> </tr> </thead> <tbody> <tr> <td>VM1775A0</td> <td>OPAQUE SILVER KEY WITH GOLD CLOUD</td> <td>1.000</td> <td>PC</td> </tr> <tr> <td>VM1776A0</td> <td>"GOLD "0-1" MATT SILVER KEY"</td> <td>1.000</td> <td>PC</td> </tr> </tbody> </table>	Code	Description	Qty	UOM	VM1775A0	OPAQUE SILVER KEY WITH GOLD CLOUD	1.000	PC	VM1776A0	"GOLD "0-1" MATT SILVER KEY"	1.000	PC																																	
			Code	Description	Qty	UOM																																												
VM1775A0	OPAQUE SILVER KEY WITH GOLD CLOUD	1.000	PC																																															
VM1776A0	"GOLD "0-1" MATT SILVER KEY"	1.000	PC																																															
KVE0007A	XF-XG LED AND LED COVERS KIT	<table border="1"> <thead> <tr> <th>Code</th> <th>Description</th> <th>Qty</th> <th>UOM</th> </tr> </thead> <tbody> <tr> <td>VE1170A0</td> <td>D16 OPAQUE NICKEL ELLIPTICAL SUPPORT</td> <td>5.000</td> <td>PC</td> </tr> <tr> <td>VE1530A0</td> <td>GOLD THERMOMETE R BLUE LIGHT COVER</td> <td>1.000</td> <td>PC</td> </tr> <tr> <td>VE1535A1</td> <td>230V WHITE LED</td> <td>1.000</td> <td>PC</td> </tr> <tr> <td>VE1562A0</td> <td>UNIPOLAR NA PUSH BUTTO</td> <td>1.000</td> <td>PC</td> </tr> <tr> <td>VE1585A0</td> <td>BLUE LIGHT COVER GOLD SINUSOID</td> <td>1.000</td> <td>PC</td> </tr> <tr> <td>VM1762A0</td> <td>INNER LAMP SUPPORT</td> <td>4.000</td> <td>PC</td> </tr> <tr> <td>VM1767A0</td> <td>GREEN PILOT LIGHT W/ GOLD FLAME</td> <td>1.000</td> <td>PC</td> </tr> <tr> <td>VM1774A0</td> <td>SILVER OPAQUE KEY W/ GOLD FLAME</td> <td>1.000</td> <td>PC</td> </tr> <tr> <td>VM1775A0</td> <td>OPAQUE SILVER KEY WITH GOLD CLOUD</td> <td>1.000</td> <td>PC</td> </tr> <tr> <td>VM1902A0</td> <td>NEUTRAL GREEN PLASTIC COVER FOR</td> <td>1.000</td> <td>PC</td> </tr> <tr> <td>VM1903A0</td> <td>GREEN PILOT WITH GOLD "CLOUD"</td> <td>1.000</td> <td>PC</td> </tr> </tbody> </table>	Code	Description	Qty	UOM	VE1170A0	D16 OPAQUE NICKEL ELLIPTICAL SUPPORT	5.000	PC	VE1530A0	GOLD THERMOMETE R BLUE LIGHT COVER	1.000	PC	VE1535A1	230V WHITE LED	1.000	PC	VE1562A0	UNIPOLAR NA PUSH BUTTO	1.000	PC	VE1585A0	BLUE LIGHT COVER GOLD SINUSOID	1.000	PC	VM1762A0	INNER LAMP SUPPORT	4.000	PC	VM1767A0	GREEN PILOT LIGHT W/ GOLD FLAME	1.000	PC	VM1774A0	SILVER OPAQUE KEY W/ GOLD FLAME	1.000	PC	VM1775A0	OPAQUE SILVER KEY WITH GOLD CLOUD	1.000	PC	VM1902A0	NEUTRAL GREEN PLASTIC COVER FOR	1.000	PC	VM1903A0	GREEN PILOT WITH GOLD "CLOUD"	1.000	PC
Code	Description	Qty	UOM																																															
VE1170A0	D16 OPAQUE NICKEL ELLIPTICAL SUPPORT	5.000	PC																																															
VE1530A0	GOLD THERMOMETE R BLUE LIGHT COVER	1.000	PC																																															
VE1535A1	230V WHITE LED	1.000	PC																																															
VE1562A0	UNIPOLAR NA PUSH BUTTO	1.000	PC																																															
VE1585A0	BLUE LIGHT COVER GOLD SINUSOID	1.000	PC																																															
VM1762A0	INNER LAMP SUPPORT	4.000	PC																																															
VM1767A0	GREEN PILOT LIGHT W/ GOLD FLAME	1.000	PC																																															
VM1774A0	SILVER OPAQUE KEY W/ GOLD FLAME	1.000	PC																																															
VM1775A0	OPAQUE SILVER KEY WITH GOLD CLOUD	1.000	PC																																															
VM1902A0	NEUTRAL GREEN PLASTIC COVER FOR	1.000	PC																																															
VM1903A0	GREEN PILOT WITH GOLD "CLOUD"	1.000	PC																																															
KLP1014A	SINUSOID LED LIGHT+COVER+SUPPORT KIT	<table border="1"> <thead> <tr> <th>Code</th> <th>Description</th> <th>Qty</th> <th>UOM</th> </tr> </thead> <tbody> <tr> <td>VE1170A0</td> <td>D16 OPAQUE NICKEL ELLIPTICAL SUPPORT</td> <td>2.000</td> <td>PC</td> </tr> <tr> <td>VE1535A1</td> <td>230V WHITE LED</td> <td>2.000</td> <td>PC</td> </tr> <tr> <td>VE1585A0</td> <td>BLUE LIGHT COVER GOLD SINUSOID</td> <td>2.000</td> <td>PC</td> </tr> </tbody> </table>	Code	Description	Qty	UOM	VE1170A0	D16 OPAQUE NICKEL ELLIPTICAL SUPPORT	2.000	PC	VE1535A1	230V WHITE LED	2.000	PC	VE1585A0	BLUE LIGHT COVER GOLD SINUSOID	2.000	PC																																
Code	Description	Qty	UOM																																															
VE1170A0	D16 OPAQUE NICKEL ELLIPTICAL SUPPORT	2.000	PC																																															
VE1535A1	230V WHITE LED	2.000	PC																																															
VE1585A0	BLUE LIGHT COVER GOLD SINUSOID	2.000	PC																																															

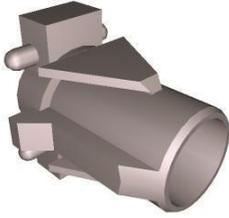

COMPONENT			SPARE PART																							
Code	Description	Image	Code	Description	Kit components																					
VE1535A	230V WHITE LED		KLP1014A	SINUSOID LED LIGHT+COVER+SUPPORT KIT	<table border="1"> <thead> <tr> <th>Code</th> <th>Description</th> <th>Qty</th> <th>UOM</th> </tr> </thead> <tbody> <tr> <td>VM1762A0</td> <td>INNER LAMP SUPPORT</td> <td>2.000</td> <td>PC</td> </tr> <tr> <td>VM2009A0</td> <td>D16 SILVER ELLIPTICAL SUPPORT</td> <td>1.000</td> <td>PC</td> </tr> </tbody> </table>	Code	Description	Qty	UOM	VM1762A0	INNER LAMP SUPPORT	2.000	PC	VM2009A0	D16 SILVER ELLIPTICAL SUPPORT	1.000	PC									
			Code	Description	Qty	UOM																				
			VM1762A0	INNER LAMP SUPPORT	2.000	PC																				
VM2009A0	D16 SILVER ELLIPTICAL SUPPORT	1.000	PC																							
KLP1012A	GOLDEN THERMOMETER BLUE LIGHT KIT	<table border="1"> <thead> <tr> <th>Code</th> <th>Description</th> <th>Qty</th> <th>UOM</th> </tr> </thead> <tbody> <tr> <td>VE1170A0</td> <td>D16 OPAQUE NICKEL ELLIPTICAL SUPPORT</td> <td>1.000</td> <td>PC</td> </tr> <tr> <td>VE1530A0</td> <td>GOLD THERMOMETE R BLUE LIGHT COVER</td> <td>1.000</td> <td>PC</td> </tr> <tr> <td>VE1535A1</td> <td>230V WHITE LED</td> <td>1.000</td> <td>PC</td> </tr> <tr> <td>VM1762A0</td> <td>INNER LAMP SUPPORT</td> <td>1.000</td> <td>PC</td> </tr> <tr> <td>VM2009A0</td> <td>D16 SILVER ELLIPTICAL SUPPORT</td> <td>1.000</td> <td>PC</td> </tr> </tbody> </table>	Code	Description	Qty	UOM	VE1170A0	D16 OPAQUE NICKEL ELLIPTICAL SUPPORT	1.000	PC	VE1530A0	GOLD THERMOMETE R BLUE LIGHT COVER	1.000	PC	VE1535A1	230V WHITE LED	1.000	PC	VM1762A0	INNER LAMP SUPPORT	1.000	PC	VM2009A0	D16 SILVER ELLIPTICAL SUPPORT	1.000	PC
Code	Description	Qty	UOM																							
VE1170A0	D16 OPAQUE NICKEL ELLIPTICAL SUPPORT	1.000	PC																							
VE1530A0	GOLD THERMOMETE R BLUE LIGHT COVER	1.000	PC																							
VE1535A1	230V WHITE LED	1.000	PC																							
VM1762A0	INNER LAMP SUPPORT	1.000	PC																							
VM2009A0	D16 SILVER ELLIPTICAL SUPPORT	1.000	PC																							
KLP1010A	THERMOSTAT GREEN LIGHT KIT	<table border="1"> <thead> <tr> <th>Code</th> <th>Description</th> <th>Qty</th> <th>UOM</th> </tr> </thead> <tbody> <tr> <td>VE1170A0</td> <td>D16 OPAQUE NICKEL ELLIPTICAL SUPPORT</td> <td>1.000</td> <td>PC</td> </tr> <tr> <td>VE1535A1</td> <td>230V WHITE LED</td> <td>1.000</td> <td>PC</td> </tr> <tr> <td>VM1762A0</td> <td>INNER LAMP SUPPORT</td> <td>1.000</td> <td>PC</td> </tr> <tr> <td>VM1764A0</td> <td>GREEN PILOT WITH GOLD THERMOMETE</td> <td>1.000</td> <td>PC</td> </tr> </tbody> </table>	Code	Description	Qty	UOM	VE1170A0	D16 OPAQUE NICKEL ELLIPTICAL SUPPORT	1.000	PC	VE1535A1	230V WHITE LED	1.000	PC	VM1762A0	INNER LAMP SUPPORT	1.000	PC	VM1764A0	GREEN PILOT WITH GOLD THERMOMETE	1.000	PC				
Code	Description	Qty	UOM																							
VE1170A0	D16 OPAQUE NICKEL ELLIPTICAL SUPPORT	1.000	PC																							
VE1535A1	230V WHITE LED	1.000	PC																							
VM1762A0	INNER LAMP SUPPORT	1.000	PC																							
VM1764A0	GREEN PILOT WITH GOLD THERMOMETE	1.000	PC																							
VM1762A	INNER LAMP SUPPORT		KVM1762A	LAMP INTERNAL SUPPORT KIT	<table border="1"> <thead> <tr> <th>Code</th> <th>Description</th> <th>Qty</th> <th>UOM</th> </tr> </thead> <tbody> <tr> <td>VM1762A0</td> <td>INNER LAMP SUPPORT</td> <td>1.000</td> <td>PC</td> </tr> </tbody> </table>	Code	Description	Qty	UOM	VM1762A0	INNER LAMP SUPPORT	1.000	PC													
Code	Description	Qty	UOM																							
VM1762A0	INNER LAMP SUPPORT	1.000	PC																							

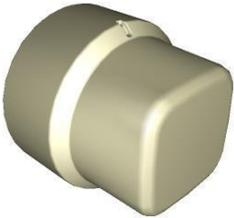
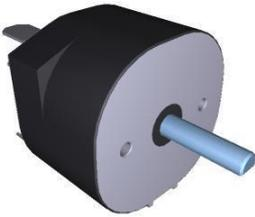
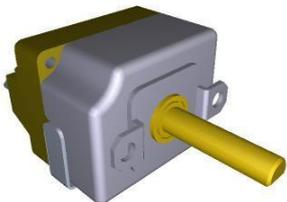

COMPONENT			SPARE PART					
Code	Description	Image	Code	Description	Kit components			
MN1100A	L.MICRO 0-60 MINUTES TIMER KNOB		KMN1101B	L.MICRO °C THERMOSTAT+TIM ER KNOBS KIT	Code	Description	Qty	UOM
					MN1120A0		1.000	PC
					MN1121A0		1.000	PC
					VM2009A0	D16 SILVER ELLIPTICAL SUPPORT	1.000	PC
MN1101B	80-260 °C THERMOSTAT KNO		KMN1101B	L.MICRO °C THERMOSTAT+TIM ER KNOBS KIT	Code	Description	Qty	UOM
					MN1120A0		1.000	PC
					MN1121A0		1.000	PC
					VM2009A0	D16 SILVER ELLIPTICAL SUPPORT	1.000	PC
TM1001C	15 SEC 120V ELECTRONIC BUZZE		KTM1001C	15 SEC BUZZER KIT	Code	Description	Qty	UOM
					TM1001C3	15 SEC 120/240V BUZZER KIT	1.000	PC
					VI1220A1	4,2x12 TCB SELF-TAPPIN G SCREW	3.000	PC
					VI1850A0	TCB M4x6 SCREW	3.000	PC
					VM1447A0	MM 230x450 PINK ESD AIRBALL BAG	0.500	PC
					VM1745A0	CARD SUPPORT	3.000	PC
TM1005A	MI2 60 MIN 250V 16A TIMER		KTM1005A	60 MIN TIMER KIT	Code	Description	Qty	UOM
					TM1005A0	MI2 60 MIN 250V 16A TIME	1.000	PC
					VI1850A0	TCB M4x6 SCREW	2.000	PC
TR1100A	269 °C 55.19052.80 ADJUSTABLE THERMOSTAT		KTR1100A	269 °C THERMOSTAT KIT	Code	Description	Qty	UOM
					TR1100A0	269 °C 55.19052.80 ADJUSTABLE THERMOSTAT	1.000	PC
					VI1850A0	TCB M4x6 SCREW	2.000	PC



COMPONENT			SPARE PART																																										
Code	Description	Image	Code	Description	Kit components																																								
VM1390B	LineMicro LISA-ANNA CONTROL PANEL		KVM1417B	CALDOBAKE SF013-SF023 COMPLETE CONTROL B	<table border="1"> <thead> <tr> <th>Code</th> <th>Description</th> <th>Qty</th> <th>UOM</th> </tr> </thead> <tbody> <tr> <td>IE1905A0</td> <td>FC-650-FMC AWG18 WHITE WIRE</td> <td>2.000</td> <td>PC</td> </tr> <tr> <td>VE1530A0</td> <td>GOLD THERMOMETE R BLUE LIGHT COVER</td> <td>1.000</td> <td>PC</td> </tr> <tr> <td>VE1535A1</td> <td>230V WHITE LED</td> <td>1.000</td> <td>PC</td> </tr> <tr> <td>VI1220A1</td> <td>4,2x12 TCB SELF-TAPPIN G SCREW</td> <td>3.000</td> <td>PC</td> </tr> <tr> <td>VM1390B1</td> <td>LCM 600 CONTROL PANEL</td> <td>1.000</td> <td>PC</td> </tr> <tr> <td>VM1762A0</td> <td>INNER LAMP SUPPORT</td> <td>1.000</td> <td>PC</td> </tr> <tr> <td>VM1794A0</td> <td>250x4.8 PA66 BLACK CLAMP</td> <td>2.000</td> <td>PC</td> </tr> <tr> <td>VM2009A0</td> <td>D16 SILVER ELLIPTICAL SUPPORT</td> <td>1.000</td> <td>PC</td> </tr> <tr> <td>VM2805A0</td> <td></td> <td>1.000</td> <td>PC</td> </tr> </tbody> </table>	Code	Description	Qty	UOM	IE1905A0	FC-650-FMC AWG18 WHITE WIRE	2.000	PC	VE1530A0	GOLD THERMOMETE R BLUE LIGHT COVER	1.000	PC	VE1535A1	230V WHITE LED	1.000	PC	VI1220A1	4,2x12 TCB SELF-TAPPIN G SCREW	3.000	PC	VM1390B1	LCM 600 CONTROL PANEL	1.000	PC	VM1762A0	INNER LAMP SUPPORT	1.000	PC	VM1794A0	250x4.8 PA66 BLACK CLAMP	2.000	PC	VM2009A0	D16 SILVER ELLIPTICAL SUPPORT	1.000	PC	VM2805A0		1.000	PC
			Code	Description	Qty	UOM																																							
IE1905A0	FC-650-FMC AWG18 WHITE WIRE	2.000	PC																																										
VE1530A0	GOLD THERMOMETE R BLUE LIGHT COVER	1.000	PC																																										
VE1535A1	230V WHITE LED	1.000	PC																																										
VI1220A1	4,2x12 TCB SELF-TAPPIN G SCREW	3.000	PC																																										
VM1390B1	LCM 600 CONTROL PANEL	1.000	PC																																										
VM1762A0	INNER LAMP SUPPORT	1.000	PC																																										
VM1794A0	250x4.8 PA66 BLACK CLAMP	2.000	PC																																										
VM2009A0	D16 SILVER ELLIPTICAL SUPPORT	1.000	PC																																										
VM2805A0		1.000	PC																																										
KVM1390B	LINEMICRO LISA-ANNA CONTROL PANEL KI	<table border="1"> <thead> <tr> <th>Code</th> <th>Description</th> <th>Qty</th> <th>UOM</th> </tr> </thead> <tbody> <tr> <td>IE1905A0</td> <td>FC-650-FMC AWG18 WHITE WIRE</td> <td>2.000</td> <td>PC</td> </tr> <tr> <td>VE1530A0</td> <td>GOLD THERMOMETE R BLUE LIGHT COVER</td> <td>1.000</td> <td>PC</td> </tr> <tr> <td>VE1535A1</td> <td>230V WHITE LED</td> <td>1.000</td> <td>PC</td> </tr> <tr> <td>VI1220A1</td> <td>4,2x12 TCB SELF-TAPPIN G SCREW</td> <td>3.000</td> <td>PC</td> </tr> <tr> <td>VM1390B1</td> <td>LCM 600 CONTROL PANEL</td> <td>1.000</td> <td>PC</td> </tr> <tr> <td>VM1762A0</td> <td>INNER LAMP SUPPORT</td> <td>1.000</td> <td>PC</td> </tr> <tr> <td>VM2009A0</td> <td>D16 SILVER ELLIPTICAL SUPPORT</td> <td>1.000</td> <td>PC</td> </tr> </tbody> </table>	Code	Description	Qty	UOM	IE1905A0	FC-650-FMC AWG18 WHITE WIRE	2.000	PC	VE1530A0	GOLD THERMOMETE R BLUE LIGHT COVER	1.000	PC	VE1535A1	230V WHITE LED	1.000	PC	VI1220A1	4,2x12 TCB SELF-TAPPIN G SCREW	3.000	PC	VM1390B1	LCM 600 CONTROL PANEL	1.000	PC	VM1762A0	INNER LAMP SUPPORT	1.000	PC	VM2009A0	D16 SILVER ELLIPTICAL SUPPORT	1.000	PC											
Code	Description	Qty	UOM																																										
IE1905A0	FC-650-FMC AWG18 WHITE WIRE	2.000	PC																																										
VE1530A0	GOLD THERMOMETE R BLUE LIGHT COVER	1.000	PC																																										
VE1535A1	230V WHITE LED	1.000	PC																																										
VI1220A1	4,2x12 TCB SELF-TAPPIN G SCREW	3.000	PC																																										
VM1390B1	LCM 600 CONTROL PANEL	1.000	PC																																										
VM1762A0	INNER LAMP SUPPORT	1.000	PC																																										
VM2009A0	D16 SILVER ELLIPTICAL SUPPORT	1.000	PC																																										

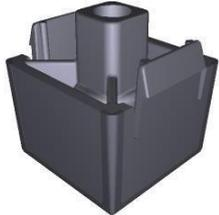
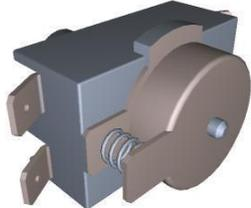

COMPONENT			SPARE PART														
Code	Description	Image	Code	Description	Kit components												
VM1750A	BRASS COMB CLAM		KVM1750A	COMB TERMINAL BLOCK KIT	<table border="1"> <thead> <tr> <th>Code</th> <th>Description</th> <th>Qty</th> <th>UOM</th> </tr> </thead> <tbody> <tr> <td>V11040A0</td> <td>INDENTED INTERNAL WASHER D=6 ZN</td> <td>2.000</td> <td>PC</td> </tr> <tr> <td>VM1750A0</td> <td>BRASS COMB CLAMP</td> <td>1.000</td> <td>PC</td> </tr> </tbody> </table>	Code	Description	Qty	UOM	V11040A0	INDENTED INTERNAL WASHER D=6 ZN	2.000	PC	VM1750A0	BRASS COMB CLAMP	1.000	PC
Code	Description	Qty	UOM														
V11040A0	INDENTED INTERNAL WASHER D=6 ZN	2.000	PC														
VM1750A0	BRASS COMB CLAMP	1.000	PC														
CR1070A	DROP DOWN DOOR HINGE LATCH		KCR1070A	LM HINGES LATCH 2 PCS. KIT	<table border="1"> <thead> <tr> <th>Code</th> <th>Description</th> <th>Qty</th> <th>UOM</th> </tr> </thead> <tbody> <tr> <td>CR1070A1</td> <td>LineMicro DROP DOWN DOOR HINGE LATCH</td> <td>2.000</td> <td>PC</td> </tr> <tr> <td>V11280A3</td> <td>M5x10 TC1/2T SCREW</td> <td>4.000</td> <td>PC</td> </tr> </tbody> </table>	Code	Description	Qty	UOM	CR1070A1	LineMicro DROP DOWN DOOR HINGE LATCH	2.000	PC	V11280A3	M5x10 TC1/2T SCREW	4.000	PC
Code	Description	Qty	UOM														
CR1070A1	LineMicro DROP DOWN DOOR HINGE LATCH	2.000	PC														
V11280A3	M5x10 TC1/2T SCREW	4.000	PC														
MR1000A	CABLE 3x1,5 H07RN-F MT1,5+K2/3+SCHUK		KMR1000A	KIT CABLE 3X1,5 H07RN-F +K2/3+SCHUKO	<table border="1"> <thead> <tr> <th>Code</th> <th>Description</th> <th>Qty</th> <th>UOM</th> </tr> </thead> <tbody> <tr> <td>MR1000A0</td> <td>CABLE 3x1,5 H07RN-F MT1,5+K2/3+S CHUKO</td> <td>1.000</td> <td>PC</td> </tr> </tbody> </table>	Code	Description	Qty	UOM	MR1000A0	CABLE 3x1,5 H07RN-F MT1,5+K2/3+S CHUKO	1.000	PC				
Code	Description	Qty	UOM														
MR1000A0	CABLE 3x1,5 H07RN-F MT1,5+K2/3+S CHUKO	1.000	PC														
PD1001A	35x35 H26 GREY PLASTIC+RUBBER FOOT		KPD1001A	35x35 H26 FEET 4 PCS KIT	<table border="1"> <thead> <tr> <th>Code</th> <th>Description</th> <th>Qty</th> <th>UOM</th> </tr> </thead> <tbody> <tr> <td>PD1001A0</td> <td>35x35 H26 GREY PLASTIC+RUBBER FOOT</td> <td>4.000</td> <td>PC</td> </tr> </tbody> </table>	Code	Description	Qty	UOM	PD1001A0	35x35 H26 GREY PLASTIC+RUBBER FOOT	4.000	PC				
Code	Description	Qty	UOM														
PD1001A0	35x35 H26 GREY PLASTIC+RUBBER FOOT	4.000	PC														
TR1134A	335°C BIPOLAR SAFETY THERMOSTAT		KTR1149A	XP/SP015 335° BIP HIGH LIMIT SWITCH KIT	<table border="1"> <thead> <tr> <th>Code</th> <th>Description</th> <th>Qty</th> <th>UOM</th> </tr> </thead> <tbody> <tr> <td>TR1134A0</td> <td>335°C BIPOLAR SAFETY THERMOSTAT</td> <td>1.000</td> <td>PC</td> </tr> </tbody> </table>	Code	Description	Qty	UOM	TR1134A0	335°C BIPOLAR SAFETY THERMOSTAT	1.000	PC				
Code	Description	Qty	UOM														
TR1134A0	335°C BIPOLAR SAFETY THERMOSTAT	1.000	PC														
			KTR1148A	XP/SP010/020 335° BIP SAFETY SWITCH KIT	<table border="1"> <thead> <tr> <th>Code</th> <th>Description</th> <th>Qty</th> <th>UOM</th> </tr> </thead> <tbody> <tr> <td>TR1134A0</td> <td>335°C BIPOLAR SAFETY THERMOSTAT</td> <td>1.000</td> <td>PC</td> </tr> </tbody> </table>	Code	Description	Qty	UOM	TR1134A0	335°C BIPOLAR SAFETY THERMOSTAT	1.000	PC				
Code	Description	Qty	UOM														
TR1134A0	335°C BIPOLAR SAFETY THERMOSTAT	1.000	PC														

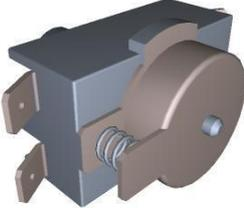
COMPONENT			SPARE PART																																						
Code	Description	Image	Code	Description	Kit components																																				
TR1134A	335°C BIPOLAR SAFETY THERMOSTAT		KTR1134A	335°C SAFETY THERMOSTAT KIT	<table border="1"> <thead> <tr> <th>Code</th> <th>Description</th> <th>Qty</th> <th>UOM</th> </tr> </thead> <tbody> <tr> <td>TR1134A0</td> <td>335°C BIPOLAR SAFETY THERMOSTAT</td> <td>1.000</td> <td>PC</td> </tr> </tbody> </table>	Code	Description	Qty	UOM	TR1134A0	335°C BIPOLAR SAFETY THERMOSTAT	1.000	PC																												
Code	Description	Qty	UOM																																						
TR1134A0	335°C BIPOLAR SAFETY THERMOSTAT	1.000	PC																																						
VE1145A	CONDENSER 3.5 µF 450 Vac 50/60 Hz		KCN1010A	3.5UF MOTOR CAPACITOR KIT	<table border="1"> <thead> <tr> <th>Code</th> <th>Description</th> <th>Qty</th> <th>UOM</th> </tr> </thead> <tbody> <tr> <td>CN1010A0</td> <td>MOTOR CAPACITOR 3.5µF 450V,CE/UL,P CLASS</td> <td>1.000</td> <td>PC</td> </tr> <tr> <td>VI1931A0</td> <td>M8x1.65 H4 CH13 ZINC PLATED NUT</td> <td>1.000</td> <td>PC</td> </tr> <tr> <td>VI1932A0</td> <td>D8 INDENTED ZINC PLATED WASHER</td> <td>1.000</td> <td>PC</td> </tr> </tbody> </table>	Code	Description	Qty	UOM	CN1010A0	MOTOR CAPACITOR 3.5µF 450V,CE/UL,P CLASS	1.000	PC	VI1931A0	M8x1.65 H4 CH13 ZINC PLATED NUT	1.000	PC	VI1932A0	D8 INDENTED ZINC PLATED WASHER	1.000	PC																				
Code	Description	Qty	UOM																																						
CN1010A0	MOTOR CAPACITOR 3.5µF 450V,CE/UL,P CLASS	1.000	PC																																						
VI1931A0	M8x1.65 H4 CH13 ZINC PLATED NUT	1.000	PC																																						
VI1932A0	D8 INDENTED ZINC PLATED WASHER	1.000	PC																																						
VM1950A	PLASTIC DRIP FLAP		<p>KVM1950A</p> <p>KVM0003A</p> <p>KVM0002A</p> <p>KVM0001A</p>	<p>LISA BACK PLASTIC DRIP FLAP KIT</p> <p>DOMENICA BACK PLASTIC DRIP FLAP KIT</p> <p>ANNA BACK PLASTIC DRIP FLAP KIT</p> <p>ROBERTA BACK PLASTIC DRIP FLAP KIT</p>	<table border="1"> <thead> <tr> <th>Code</th> <th>Description</th> <th>Qty</th> <th>UOM</th> </tr> </thead> <tbody> <tr> <td>0F1421A1</td> <td>LISA EXTERNAL BACK PANEL</td> <td>1.000</td> <td>PC</td> </tr> <tr> <td>VM1950A2</td> <td>WATER PROTECTION DRIP FLAP</td> <td>1.000</td> <td>PC</td> </tr> <tr> <td>0F1429A1</td> <td>XF043-ES BACK PANEL</td> <td>1.000</td> <td>PC</td> </tr> <tr> <td>VM1950A2</td> <td>WATER PROTECTION DRIP FLAP</td> <td>1.000</td> <td>PC</td> </tr> <tr> <td>0F1422A1</td> <td>LINEMICRO XF023 IP BACK PANEL</td> <td>1.000</td> <td>PC</td> </tr> <tr> <td>VM1950A2</td> <td>WATER PROTECTION DRIP FLAP</td> <td>1.000</td> <td>PC</td> </tr> <tr> <td>0F1420A1</td> <td>SCHIENA IP ROBERTA</td> <td>1.000</td> <td>PC</td> </tr> <tr> <td>VM1950A2</td> <td>WATER PROTECTION DRIP FLAP</td> <td>1.000</td> <td>PC</td> </tr> </tbody> </table>	Code	Description	Qty	UOM	0F1421A1	LISA EXTERNAL BACK PANEL	1.000	PC	VM1950A2	WATER PROTECTION DRIP FLAP	1.000	PC	0F1429A1	XF043-ES BACK PANEL	1.000	PC	VM1950A2	WATER PROTECTION DRIP FLAP	1.000	PC	0F1422A1	LINEMICRO XF023 IP BACK PANEL	1.000	PC	VM1950A2	WATER PROTECTION DRIP FLAP	1.000	PC	0F1420A1	SCHIENA IP ROBERTA	1.000	PC	VM1950A2	WATER PROTECTION DRIP FLAP	1.000	PC
Code	Description	Qty	UOM																																						
0F1421A1	LISA EXTERNAL BACK PANEL	1.000	PC																																						
VM1950A2	WATER PROTECTION DRIP FLAP	1.000	PC																																						
0F1429A1	XF043-ES BACK PANEL	1.000	PC																																						
VM1950A2	WATER PROTECTION DRIP FLAP	1.000	PC																																						
0F1422A1	LINEMICRO XF023 IP BACK PANEL	1.000	PC																																						
VM1950A2	WATER PROTECTION DRIP FLAP	1.000	PC																																						
0F1420A1	SCHIENA IP ROBERTA	1.000	PC																																						
VM1950A2	WATER PROTECTION DRIP FLAP	1.000	PC																																						



COMPONENT			SPARE PART														
Code	Description	Image	Code	Description	Kit components												
VM1951A	IP CHIMNEY COVER		KVM1951A	EXHAUST CHIMNEY COVER KIT	<table border="1"> <thead> <tr> <th>Code</th> <th>Description</th> <th>Qty</th> <th>UOM</th> </tr> </thead> <tbody> <tr> <td>VI1220A1</td> <td>4,2x12 TCB SELF-TAPPIN G SCREW</td> <td>2.000</td> <td>PC</td> </tr> <tr> <td>VM1951A1</td> <td>CHIMNEY COVER</td> <td>1.000</td> <td>PC</td> </tr> </tbody> </table>	Code	Description	Qty	UOM	VI1220A1	4,2x12 TCB SELF-TAPPIN G SCREW	2.000	PC	VM1951A1	CHIMNEY COVER	1.000	PC
Code	Description	Qty	UOM														
VI1220A1	4,2x12 TCB SELF-TAPPIN G SCREW	2.000	PC														
VM1951A1	CHIMNEY COVER	1.000	PC														
VM1952A	IP MOTOR COVER		KVM1952A	XF/XFT/XAF/XAFT MOTOR COVER KIT	<table border="1"> <thead> <tr> <th>Code</th> <th>Description</th> <th>Qty</th> <th>UOM</th> </tr> </thead> <tbody> <tr> <td>VI1220A1</td> <td>4,2x12 TCB SELF-TAPPIN G SCREW</td> <td>2.000</td> <td>PC</td> </tr> <tr> <td>VM1952A1</td> <td>IP MOTOR COVER KIT</td> <td>1.000</td> <td>PC</td> </tr> </tbody> </table>	Code	Description	Qty	UOM	VI1220A1	4,2x12 TCB SELF-TAPPIN G SCREW	2.000	PC	VM1952A1	IP MOTOR COVER KIT	1.000	PC
Code	Description	Qty	UOM														
VI1220A1	4,2x12 TCB SELF-TAPPIN G SCREW	2.000	PC														
VM1952A1	IP MOTOR COVER KIT	1.000	PC														